

Stuff that Works!

Guide for Professional Developers

By Gary Benenson, James Neujahr & Bradley Iverson

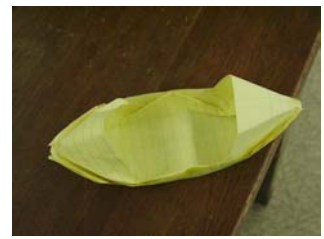
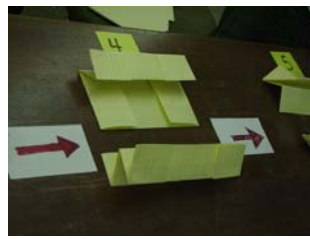
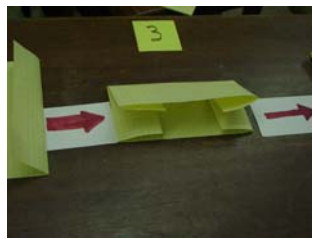
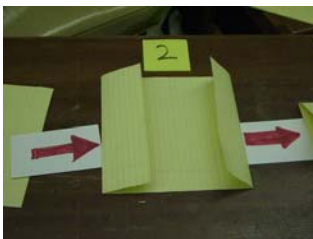

This material is based upon work supported by the National Science Foundation under Grants No. 9618767 & 0096627. Any opinions, findings, and conclusions or recommendations expressed in this material are those of the authors and do not necessarily reflect the views of the National Science Foundation.

Table of Contents

TABLE OF CONTENTS II

1. INTRODUCTION 1

PROFESSIONAL DEVELOPMENT IS A DESIGN CHALLENGE	1
BACKGROUND FOR USING THIS GUIDE	3
WHAT’S IN THE REST OF THIS GUIDE	6

2. BASICS OF WORKSHOP DESIGN 7

CONTEXT	9
GOALS	11
RESOURCES	13
CONSTRAINTS	14
TRADE-OFFS	15
EVALUATION AND REDESIGN	16

3. THE TYPICAL WORKSHOP 19

BEFORE THE WORKSHOP	19
INTRODUCTIONS	21
THE SCAVENGER HUNT OR BRAINSTORMING SESSION	22
SORTING	23
ANALYSIS	24
DESIGN	25
SHARING	26
REFLECTING ON CLASSROOM POSSIBILITIES	27

4. THORNY ISSUES 28

WHAT IS “TECHNOLOGY?”	29
DEFINITIONS, AND THE DEMAND FOR CERTAINTY	30
DOING VS. TELLING, AND THE LEARNING OF CONCEPTS	30
WHAT IS TECHNOLOGICAL DESIGN?	32
THE GROUP AND THE INDIVIDUAL: GETTING THE MOST FROM ONE ANOTHER	33
PROCESS VS. PRODUCT?	35
THE ROLE OF FAILURE IN DESIGN	37
CONTROLLED EXPERIMENTS, FAIR TESTS, AND UNFAIR ADVANTAGES	38
MATH AVOIDANCE AND THE CASE FOR QUANTITATIVE DATA	40
TECHNOLOGY AND GENDER	42
MAKING IT WORK: NEGOTIATING BARRIERS	43
DEVELOPMENTAL ISSUES	45

5. RESOURCES 47

OVERVIEW	47
----------	----

INTRODUCTORY WORKSHOP 49

<i>Overview</i>	49
<i>Workshop Materials</i>	49
<i>Preparation of Workshop Space</i>	61
SAMPLE WORKSHOP AGENDA	61

<i>Workshop Tips and Strategies</i>	61
DESIGNED ENVIRONMENTS: PLACES, PRACTICES & PLANS	67
<i>Summary of Key Concepts</i>	67
<i>Preparation of Workshop Space</i>	69
<i>Workshop Materials</i>	69
<i>Sample Workshop Agenda</i>	79
<i>Workshop Tips and Strategies</i>	82
MAPPING	79
<i>Summary of Key Concepts</i>	85
<i>Pre-workshop Activity</i>	87
<i>Workshop Materials</i>	87
<i>Sample Workshop Agenda</i>	97
<i>Workshop Tips and Strategies</i>	99
<i>Directions to Participants</i>	88
MECHANISMS & OTHER SYSTEMS	102
<i>Summary of Key Concepts</i>	102
<i>Pre-Workshop Activity</i>	104
<i>Workshop Materials</i>	104
<i>Workshop Tips and Strategies</i>	117
<i>Directions to Participants</i>	106
PACKAGING & OTHER STRUCTURES	121
<i>Summary of Key Concepts</i>	121
<i>Pre-workshop Activity</i>	123
<i>Workshop Materials</i>	123
<i>Sample Workshop Agenda</i>	132
<i>Workshop Tips & Strategies</i>	135
<i>Directions to Participants</i>	123
SIGNS, SYMBOLS & CODES	139
<i>Summary of Key Concepts</i>	139
<i>Pre-Workshop Activity</i>	141
<i>Workshop Materials</i>	141
<i>Sample Workshop Agenda</i>	152
<i>Workshop Tips and Strategies</i>	154
<i>Directions to Participants</i>	143



1. Introduction

Professional Development is a Design Challenge

This guide is intended to help you as you work with teachers, preparing them to use ***Stuff that Works!*** in their classrooms. Some teachers, already experienced in science inquiry and/or other varieties of reform-based pedagogy, will be able to use the ***Stuff that Works!*** guides without further assistance. Others may find it sufficient to partner with another teacher who is already using ***Stuff that Works!*** For most teachers, however, some formal professional development will be essential in introducing them to the ideas and activities of this new subject area. The purpose of this guide is to offer you the benefit of some of our own experiences in helping teachers implement ***Stuff that Works!***

We hope that this guide will also contribute to your practice in another way. *Design* is usually identified as the central process to be learned through activities in technology education, just as inquiry is the core process in science education. Consequently, design is a major theme of ***Stuff that Works!*** We believe that design-type strategies and design-oriented thinking can also provide guidance for many other endeavors -- including professional development! In the course of this guide, we will encourage you to think of yourself as a designer, and to see your daily tasks as a series of design problems.

What exactly do we mean by “design?” A design problem is very different from a typical textbook problem. For example, a textbook problem on ratio-and-proportion might read:

If one inch on a map represents two miles, how many inches does it take to represent seven miles?

Here is a design problem that involves the same math concepts, and much, much more:



We would like to rearrange the furniture in this classroom to make it easier to get from place to place. I have created a scale map of the room that uses one inch to represent the sides of two floor tiles, i.e., a 1 in.² grid square stands for 4 floor tiles. We will use this map to see how well different furniture

arrangements might work. Make a cardboard cutout of each piece of furniture in the room, so we can move them around on the map. Each cutout must be made to scale, or we won't be able to tell how the real furniture would fit.

Some characteristics of a design problem are:

1. The problems to be solved are of genuine significance to the problem-solvers; it *matters* to them to come up with effective solutions.
2. A solution has to satisfy a whole range of typically conflicting goals. There is no *one* best solution; a design that works well in one respect may not be effective in other ways.
3. The first try can almost always be improved upon. Design is an iterative process, in which each new attempt is informed by the strengths and weaknesses of previous efforts.

The design challenge of professional development is to create, test, and redesign methods of supporting teachers in using new curriculum ideas, and in modifying these ideas as appropriate. Because we see professional development as an ongoing design problem, we will not present any formulas or final answers in this guide. Instead, our goal is share some of the strengths and weaknesses of designs that we have already tried. An essential ingredient in any serious design process is to analyze and learn from one's own mistakes and failures.

In this guide, we will outline what we think are the major features of this design problem, including goals, available resources, criteria, constraints and evaluation methods. We will also offer some concrete suggestions for getting started with professional development for ***Stuff that Works!*** These include workshop agendas, tips for collecting materials and managing workshops, and summaries of the major concepts of the five ***Stuff that Works!*** topics.

Of course, many of the most interesting and challenging issues arise *after* the workshop, during the period of classroom implementation. We will discuss some of these issues as well, and suggest approaches for handling them. It is important to follow up with teachers after the workshop, and there are a variety of ways of doing so. It may be possible to schedule an additional session or two, stay in touch with teachers by phone, email, or in-person, or set up on-line or face-to-face courses, to support teachers during the initial implementation phase. Chapters 2, 4 and 5 provide additional information about the kinds of issues that arise after the workshop, and about course work that has been developed to address these issues.

Nothing in this guide is definitive or final. Our only goal is to offer starting points for creating your own designs. We welcome your ideas, experiences and redesigns, which will help us to make this a dynamic, living document.

Background for Using this Guide

During the 1999-2000 Academic Year, the ***Stuff that Works!*** materials were field-tested at five sites. These included two in New York City, one in New York's northern suburbs, and one each in Michigan and Nevada. In preparation for the field tests, the project staff conducted a Summer Institute for eleven professional developers from the five sites. During the following year, these professional developers conducted workshops at their own sites, and recruited local teachers to field test the materials in their own classrooms.

The Center for Children and Technology of the Education Development Center (CCT/EDC) conducted an evaluation study using data from the field tests. Sources of data included direct observation of the Summer Institute and local Professional Development workshops, structured journals kept by the professional developers, interviews with them, surveys completed by teachers, and teachers' classroom portfolios. The purposes of the CCT study were to investigate the strategies used by professional developers, as well as the issues they confronted, as they prepared teachers to use ***Stuff that Works!*** The lessons learned from this study were a major source of information for the writing of this guide.

More recently, the ***Stuff that Works!*** materials have been adopted and adapted by professional developers and teachers in Alaska, Arizona, Florida, Wisconsin, New York, California, Georgia, Louisiana, Massachusetts, Michigan, Mississippi, New Jersey, Ohio, Tennessee, Virginia, Nevada and West Virginia. At these sites, many new ideas have been generated, some of which have led to redesign of the workshops and creation of new course materials described in Chapter 5. Two examples deserve special mention: the Portfolio Review component of each Sample Course /Work section is based on the work of Bradley Iverson and Theodore Small at Southern Nevada Regional Professional Development Program and Southern Utah University; and the Technology Scavenger Hunt component of the Introductory Workshop was developed by Al Cote at Ohio University. More generally, the many comments and suggestions of professional developers during and after City Technology summer institutes have been invaluable in helping to refine and improve each activity.

In order to use this document effectively, there are two things we recommend that you do first:

1. Obtain a copy of at least one of the ***Stuff that Works!*** teacher guides, and become familiar with it. We will not repeat any of the material in the teachers' guides, except to include a summary of the *Concepts* (Chapter 2 of each guide).
2. Try out some of the activities in *Appetizers* (Chapter 1 of each guide). There is simply no better way to get a sense of ***Stuff that Works!*** than by collecting and examining stuff for yourself.

Before you start, you should also know our basic assumptions about technology education and about professional development. Some of these assumptions may not be generally accepted, so they are worth summarizing here. We will return to them frequently throughout this guide.

Assumptions about technology:

- 1. Technology includes far more than computers.** Somehow, the idea that “technology” means “computers” has become firmly entrenched in education. Computers are only one small aspect of technology, and are not really accessible for elementary-level analysis and design.
- 2. Technology is all around you, often free, easy to begin studying and frequently full of surprises.** Without much effort, you can find abundant examples of technology in your kitchen, bathroom, or classroom, or in the garbage. Nail clippers, staple removers, shopping bags, furniture arrangements and street signs are very familiar, which makes them appealing subjects for study. Better yet, these technologies contain some real challenges and offer abundant opportunities for learning.
- 3. Design is the distinctive activity of technology.** The goal of science is to generate new knowledge. Technology has a related, but different goal: to design, test, and redesign solutions to problems that people encounter in their lives.
- 4. Technology does not only include artifacts.** The most obvious examples of technology are artifacts, i.e., objects designed by people to make life easier or more pleasant. Borrowing a term from computers, these constitute the *hardware* component of technology. We also include the *software* aspect: the procedures or plans for mobilizing and using the hardware. For example, a door is an example of hardware; a practice such as “knock before you enter” is an example of software. Both hardware and software can be open to design and/or redesign.
- 5. The problems students solve should be *their* problems.** Too much of education dwells on the solutions to problems that students have never actually faced. Technology education provides the opportunity to address problems of real concern to students. Some of the ***Stuff that Works!*** activities include creating classroom storage space, finding ways to package fragile or heavy objects, dealing with classroom interruptions, nurturing classroom pets, and improving traffic flow in the school.

Assumptions about professional development

- 1. Teachers are learners.** Professional development workshops should engage teachers in the excitement and fun of learning. By having these experiences themselves, they become more likely to see the benefits for their students.

2. **Teachers are experts.** Nobody has more practical knowledge than teachers do about classrooms, classroom interactions, the possibilities for learning, and the numerous obstacles to education. Professional developers should honor the voices of teachers, and provide opportunities for them to learn from one another.
3. **Learning is not a necessary outcome of teaching.** People learn much more from what they do than from what they are told. Professional development workshops should be informal, active affairs, where most of the time is spent doing and interacting, rather than being told what to think or do.
4. **Much of the task of professional development takes place in the planning and preparation of the workshop, perhaps more than in actually leading it.** A well-planned workshop will often seem to “run itself.” Sometimes it may seem that you are not doing very much as “leader” of a workshop. Nevertheless, there will be moments, particularly at the beginning, when you will need to get a sense of the participants and figure out how to frame the experience for them. Good workshop design strikes a balance between preplanning and responding flexibly to unexpected events.

What's in the rest of this Guide

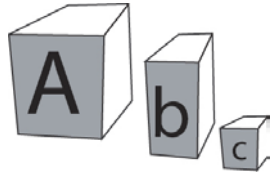

- **Chapter 2: Basics of Workshop Design** develops the theme that professional development is a design problem. It describes the steps in a typical design process, and applies them to the problem of professional development.



- **Chapter 3: The Typical Workshop** describes the generic components of a *Stuff that Works!* workshop. These include preparing for the workshop, introductions, brainstorming and scavenger hunts, sorting, analysis, design, sharing and reflecting on classroom possibilities.



- **Chapter 4: Thorny Issues** handles some of the challenges that have arisen during or after our workshops, such as use of technical language, development of concepts, collaborative learning, controlled experiments, math avoidance, gender issues, administrative barriers, and developmental appropriateness.



- **Chapter 5: Resources** provides materials for offering professional development workshops designed to support each of the five *Stuff that Works!* topics. These workshops include an introductory session, which can take as little as an hour, plus five workshops, one per topic, lasting up to half a day. Each of the workshop descriptions includes a summary of concepts, a pre-workshop scavenger hunt, a list of workshop materials, directions to participants, a sample workshop agenda, as well as tips and strategies. The six workshops are summarized in the table below, which includes times for each activity, and recommended grade levels. Based on this table, each of the workshops can be broken up into shorter segments if necessary and upper-grade materials can be omitted, if the participants are from the lower grades.

Table 1: Overview of City Technology Workshops

Topic	Brainstorming/ Scavenger Hunt	Sorting	Analysis	Design
Introductory Workshop	Design and Technology examples from everyday experience (15 min.)		Five sample activities, done by groups in parallel, one from each of the five City Technology topics, followed by sharing by each group (45 min.)	
Designed Environments	Brainstorming list of problems with workshop space (20 min.)		Redesign of workshop space and subsequent evaluation of redesigned space (60 min.)	
	Brainstorming list of classroom design challenges (30 min.)		Analysis of experience of playing Connect Four; redesign and evaluation of new rules for playing (60 min.)	
Mapping	Scavenger hunt through magazines and newspapers for maps (10 min.)	Sorting maps according to secret categories (30 min.)	Determining the characteristics of a map of physical space (20 min.)	Mystery table arrangement (40 min.)
				Quick map of workshop space (30 min.)
				Scale map of workshop space (40 min.)
Packaging	Brainstorming list of examples of packaging (15 min.)	Sorting shopping bags according to secret categories (30 min.)	Predicting bag failure modes (30 min.)	Making shopping bags from lunch bags (15 min.)
			Analysis of failure modes of lunch-bag shopping bags; redesign based on analysis (60 minutes)	

Topic	Brainstorming/ Scavenger Hunt	Sorting	Analysis	Design
Mechanisms	Search for mechanisms; deciding characteristics they share in common (20 min.)	Sorting mechanisms according to secret categories (30 min.)	Analyzing levers according to first-, second- and third-class (20 min.)	Mystery Mechanisms (60 min.) NOTE: Modeling simple mechanisms can be used as lower-grade alternative; see <u>Mechanisms</u> segment of Smorgasbord in Introductory Workshop.
			Identifying compound levers, classifying and representing individual levers (40 min.)	
Packaging	Brainstorming list of examples of packaging (15 min.)	Sorting shopping bags according to secret categories (30 min.)	Predicting bag failure modes (30 min.)	Making shopping bags from lunch bags (15 min.)
			Analysis of failure modes of lunch-bag shopping bags; redesign based on analysis (60 minutes)	
Signs, Symbols & Codes	Scavenger hunt through newspapers for symbols (10 min.)	Sorting symbols according to secret categories (30 min.)	Examining museum floor plans for good and bad symbols (30 min.)	Design a symbol to convey a secret message (30 min.)
				Design a graphic instruction manual (45 min.)

Key:

Suitable for all grade
levels



Most suitable for upper
elementary grades



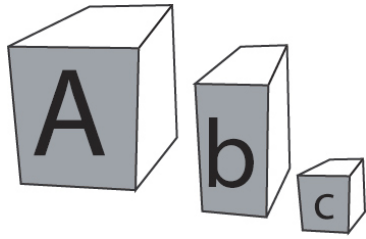

2. Basics of Workshop Design

This chapter applies some basic principles of design to the problem of designing, testing and redesigning a professional development workshop. We look at the planning of workshops in the same way that we might look at the design of an artifact or an environment: What are the design goals? What resources exist? What constraints complicate the design? What trade-offs need to be made in order to balance conflicting requirements? How should the design be evaluated? How can it be redesigned to do its job better?

Context

There are many circumstances of professional development, and these will inevitably affect the design of workshops and other professional development experiences. The scale of professional development ranges from one teacher mentoring another, to massive projects that engage most or all of the teachers in a school or district. In our experience, the optimum size for a workshop is about 15 - 20 participants. While most of our own workshops have had between 10 and 25 participants, we have also conducted them for as few as three teachers and for as many as 60. Within a small workshop, the facilitator may need to provide some of the idea generation that would normally come from the cross-fertilization among work groups, as they share their thoughts and findings. Very large workshops require more attention to logistics than small ones. For example, room setup is more important, and there may not be enough time to allow each group to share each of its activities. In Chapter 3, p. 20, we outline some strategies for organizing sharing.

Sometimes, you will be involved in recruiting participants, but often others will perform this task. If possible, you should play some role in this process, in order to help prepare teachers for the experience. Teachers tend to be wary of new curricula that must be crammed into an already overcrowded school day. In addition, many will assume that “technology” once again means “computers,” to which they may not have access. The recruitment process can address some of these issues.

What could motivate teachers to attend an initial workshop? We have found that those who have had some form of exposure usually want to get more involved with *Stuff that Works!* Here are some strategies that have worked in giving them a first taste:

- ❑ Provide informative material showing how *Stuff that Works!* fits into their existing programs and addresses relevant standards in science, math, language arts and/or technology.
- ❑ Conduct an introductory “smorgasbord” event that provides quick exposure to all five *Stuff that Works!* topics. Teachers will then get a sense of what the curriculum is all about, and be able to make informed choices about participating.
- ❑ Distribute sample materials from the *Stuff that Works!* guides; offer to provide participants with a complete book, if they attend a workshop.

Whether or not you were directly involved in recruitment, you should at least *know* the conditions surrounding the teachers’ participation:

- ❑ Are they being paid or not?
- ❑ Did they volunteer, or were they required to attend?
- ❑ How much advance notice did they receive?
- ❑ What do they think will happen in the workshop?

Another basic ingredient is the timing of a workshop. In general, teachers are busy people, for whom every moment of the week is precious. If possible, try to involve some of the participants in deciding the time and place of a workshop. At a minimum, you should be sensitive to the hectic lives of the participants, and try to mitigate their difficulties in attending. Some ways of doing so are:

- ❑ Providing clear directions to the workshop site;
- ❑ Beginning and ending on time;
- ❑ Providing refreshments;
- ❑ Attending to amenities, such as parking, telephone access, storage space for coats and other personal property, convenient access to rest rooms;
- ❑ [If the workshop is held during school hours,] acknowledging the difficulty of leaving the classroom with a substitute; or
- ❑ [If the workshop takes place during an evening or weekend,] acknowledging teachers’ family and professional responsibilities.

Each of these measures expresses your commitment to treating the participants as professionals, and sets a positive tone for the entire workshop.

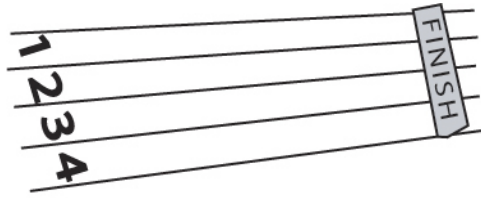

Goals

By definition, any design project is intended to accomplish some end. When a teacher designs a lesson or a homework assignment, she has a purpose in mind. The same thing is true of a professional development workshop. Specifying goals is complicated by the fact that everyone may not share the same objectives. For example, your goals may be different from those of the teachers who attend your workshop, or those of the administrators who authorize it. For example, a school or district may plan a workshop simply to raise the morale of teachers; but the workshop leaders may want to accomplish more than that. Furthermore, goals may change in the course of an activity. Participants may become aware of possibilities that weren't obvious at the outset. As with any other design problem, there are nearly always multiple goals to be accomplished, and these sometimes conflict.

Here are some possible goals for a professional development program based on *Stuff that Works!*:

1. To help teachers address new district-level or statewide requirements in technology education;
2. To promote the introduction of technology education as a vehicle for meeting goals in other subject areas;
3. To support teachers in developing new conceptions of the nature and role of technology in education;
4. To motivate and enable teachers to implement design and technology activities in their own classrooms;
5. To offer models for the conduct of cooperative learning activities;
6. To demonstrate the possibilities for interdisciplinary projects based on technology themes;
7. To organize teachers in teams to promote school-wide implementation of a new curriculum;

8. To support teachers in providing enjoyable classroom activities that also support literacy, promote self-esteem, and provide relief from the drudgery of test preparation.

Of course, these goals may overlap, and many other goals could be added. Whatever your goals might be, we suggest that you formulate them explicitly at the outset.

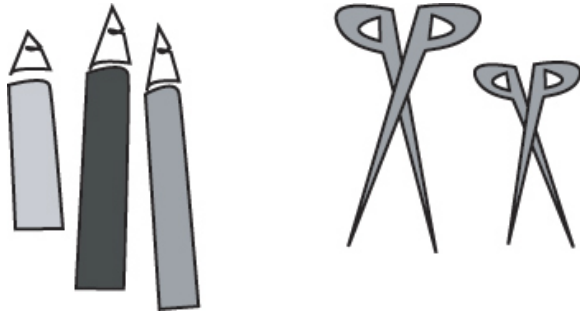

Resources

Any design problem -- including professional development design -- begins with a set of resources available to help solve the problem. The most obvious resources for professional development are tangible. These include space, furniture, materials, money, and people. Others are not so tangible, such as time, imagination and experience. In planning professional development experiences, it is important to know what resources are available.

One of the guiding principles of *Stuff that Works!* is that the budget for classroom materials is roughly zero. The same should be true for workshop materials. Where can these materials come from? Finding appropriate materials is the purpose of a scavenger hunt or brainstorming session, which is the opening activity for each of the *Stuff that Works!* topics. These are described in the next chapter. Workshop materials for each topic are listed in Chapter 5.

Another tangible resource is workshop space. It is important to be familiar with the room beforehand, and to plan how you will organize it. Also, it is a good idea to find out how long *before* the workshop you will have access to the room, because you may need time to set up the materials and/or rearrange the furniture. If the room will be occupied up to the last minute, you may have to be creative.

Two of us were once scheduled to do a Packaging workshop in a conference center room that would not be available until ten minutes before the start of our session. To conduct our workshop, we had to provide the participants with a large volume of discarded packaging material. There simply wouldn't be time to set all of this up in ten minutes. Our solution was to interpret the corridor outside the room as part of our workshop space. In a storage area, we found long tables, which we moved into this hallway well in advance of the workshop. When the room finally became available, most of the setup was already done!

An often-overlooked resource includes the ideas and experiences of the participants themselves. By focusing on everyday artifacts and problems, *Stuff that Works!* provides many opportunities to draw upon the collective knowledge of the group. For example, cooking enthusiasts in a workshop on Mechanisms are likely to be very knowledgeable about some of the more exotic kitchen mechanisms, like egg toppers, apple corers, garlic presses, melon ballers and cookie droppers. Signs, Symbols & Codes

is enriched by a wide variety of background interests -- for example, in sports, games, crafts, hobbies, music and dance -- because each of these endeavors has its own specialized symbols and codes. Participants' experiences are especially critical to work on Designed Environments. Most of the data needed for redesign of a desk, a classroom, or a cafeteria comes from direct experience about how well or poorly existing designs serve their purposes.

The greatest contribution of teachers to a workshop is likely to be about the subject they know best: the classroom. Nobody knows more about what actually takes place there, what kinds of things are possible, how to accomplish them and the barriers to both teaching and learning. It is essential to provide opportunities for teachers to voice their observations, doubts, and frustrations, so that you and they can work through the problems together. Incorporating the participants' experiences and ideas is an essential component of a successful workshop.



Constraints

The most obvious constraint is time. This is the classic zero-sum game: a decision to devote more time to one activity means spending less time on something else. Even with the best design, you will need to use judgment during the workshop to adjust to the circumstances. It may take some experience to recognize that an activity has gone on long enough; or to decide that a question raised by a teacher is worth pursuing, even at the expense of sacrificing something else.

Another kind of constraint is the lack of a necessary resource. Inadequate workshop space, supplies that are missing, and lack of experience all seem like constraints. Often, creative on-the-spot redesign can overcome these kinds of obstacles.

For a Mechanisms workshop led by one of the authors, the organizers had provided cardboard strips with the corrugations running the short way rather than the long way (see Mechanisms & Other Systems, p. 21, Fig. 1-35 F & G). It was hard to make models with these strips, because they tended to buckle when pushed. The participants figured out a variety of creative solutions to this problem, such as reinforcing the cardboard with coffee stirrers taken from the snack table!

The educational system also imposes some very powerful constraints on how teachers can use what they have learned in a workshop. These are the implementation

issues that linger in the background as teachers consider what will be possible in their own classrooms. They ask themselves questions like these:

- ❑ Is my class size too big for this?
- ❑ Where will I find the time for it?
- ❑ Will my principal accept it?
- ❑ Will it help me accomplish my goals in other subject areas?
- ❑ How will I store all of the materials?

These constraints really apply to the *teacher's* design problem, not that of the professional developer. However, the workshop leader ought to acknowledge these problems, and help teachers think them through. See also "Negotiating Barriers," Pp. 34-35.

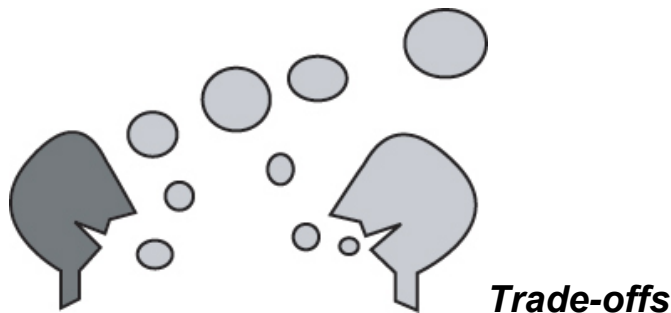

No one workshop can possibly achieve all of its goals. In a morning, a day or even a week, it is simply impossible to engage teachers in a new subject matter, *and* teach them basic content, *and* elicit their ideas and reflections, *and* fully prepare them for classroom implementation, *and* develop connections with other subject areas. Clearly, the professional developer needs to establish a system of priorities, and decide consciously to sacrifice some goals in favor of others. In the jargon of design, this process is called "making trade-offs." Like every other aspect of the design, the trade-offs should be evaluated, and perhaps done differently the next time.

A common dilemma pits the following goals against each other:

1. Allowing further discussion
- vs.
2. Keeping to the workshop schedule.

Often, it is worth allowing the discussion to continue, even at the cost of not “covering” everything. However, sometimes a discussion will wander from the topic at hand, provide a platform for someone who simply likes to talk, or degenerate into a “gripe session.” In any of these circumstances, it is reasonable to move on.

Sometimes, participants will question the reasons for using one approach as opposed to another, in a workshop or a classroom. It is worth discussing the concept of trade-offs, and pointing out that every teacher makes many such trade-offs in the course of a school day. She may decide, for example, to finish an activity that is going well, although it means not beginning the next one. Conversely, she may end an activity prematurely, in order *not* to sacrifice the following activity. When a teacher asks about how and why a particular trade-off was made in conducting a workshop, it gives you an opportunity to solicit her views. Any opinion about your workshop design is a piece of data for examining it critically and perhaps for revising it for the next go-round.

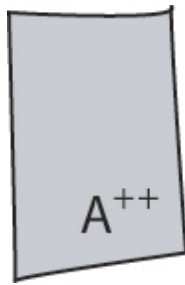

Evaluation and Redesign

At its best, evaluation benefits professional development in the same way that it benefits other designs. However, it is often experienced at its worst because it is done so poorly. For this reason, many in education regard evaluation as a necessary evil. During professional development, evaluation is frequently a rote exercise, undertaken mainly to prove that it was done, rather than as part of a design process that can lead to improving the design. In some districts, teachers have even been disciplined for expressing candid views on evaluation forms! The typical “feedback” form, often the sole evaluation instrument, is distributed and collected at the end of a workshop. This form may yield little if any data that could be useful to the designers. For example, the stereotypical survey question, “What one word would you use to describe this workshop?” cannot be very helpful towards redesigning it.

Because we regard professional development as a design problem, we take evaluation very seriously. It is the process of answering the most fundamental question about a proposed design: *To what extent did it satisfy the design goals?* For the purpose of evaluation, the design goals are usually refined into a set of *criteria*, which are more focused statements of the goals. For example, suppose one goal of a workshop on the topic of Packaging is to promote a broader view of the scope of technology. A corresponding criterion for evaluating the workshop design might be: *Did the participants recognize bags, bottles and boxes as examples of technology?*

What sort of data is useful for evaluating a workshop design? How can this data be collected? These are difficult questions, which partly require the expertise of professional evaluators. Nevertheless, there are some aspects that are fairly intuitive. Evaluation of a workshop is similar to assessment of a lesson. After it is over, nearly every teacher has a pretty good sense of whether it “worked” or it didn’t. Similarly, after doing a workshop, it is usually fairly obvious whether or not it “went well.” Some clues for an intuitive positive or negative feeling about a workshop are:

- ❑ How engaged the teachers were in the activities; reflected, for example, by how reluctant they are to stop working;
- ❑ How much they participated in discussion and reflection;
- ❑ Whether or not some stayed afterwards to engage in further discussion;
- ❑ Informal comments they made, such as “It was worth fighting the traffic to get here,” vs. “How long before we get paid?”

Beyond this “gut-feeling,” there are also more objective sources of data. Again, there is an analogy to what happens in the classroom. When teachers assess what children have learned, they are also finding out how well they have achieved their own goals as educators. Data for assessment comes from many sources: not only pencil-and-paper tests, but also children’s dialogue, homework, oral presentations, questions, comments and drawings. Chapter 5 of each of the *Stuff that Works!* materials contains a section on assessment that outlines some of these methods. Assessment of children’s learning is also evaluation of a teacher’s educational program.

In a similar way, everything teachers do in a workshop provides data for evaluating the professional development program. Participants’ written work, models, comments, questions, and presentations all reveal something about how effective the experience has been for them. It is important to collect, organize and analyze these workshop products carefully. Teachers may *enjoy* a workshop immensely -- simply because the activities are fun -- without really grasping the ideas that the workshop was intended to convey. By looking at the work the teachers did, you can usually get a pretty good sense of how well they assimilated the key concepts.

Of course, the goals of a professional development workshop extend beyond the workshop experience itself. A major goal is for the concepts and attitudes developed through the workshop to translate into classroom practice. Ideally, then, the evaluation study would follow the teachers back into their classrooms. Unfortunately, few professional development programs have the resources to do this kind of research. As a first step, it is useful to set aside time near the end for teachers to plan and discuss how the workshop activities might play out in the classroom. If resources are available, a follow-up workshop can explore implementation issues. Alternatively, you might suggest that the participants remain in contact with you, perhaps by email, as questions and issues arise within their classrooms. More extensively, the City Technology project has developed a set of sample courses to support teachers during the period of classroom

implementation. These courses are described at the beginning of Chapter 4 (p. 22), and outlined for each topic in Chapter 5. Any of these forms of support can generate valuable data for redesign of the professional development experiences.



3. The Typical Workshop

In this chapter, we develop a generic model for a professional development workshop. In our own workshops, we have generally used this model as a template, modifying it according to circumstances. Because we believe that the workshop should serve as a model for the classroom, the ingredients of the typical workshop are also the major elements of the *Stuff that Works!* activities. Therefore, you should find close parallels between the items in this chapter, and the activities for children in Chapter 3 of each of the *Stuff that Works!* teacher guides. In the final chapter of this document, we will provide a sample workshop agenda for each of the five *Stuff that Works!* topics.

Before the Workshop

There are a number of steps you should take before actually conducting a workshop:

1. **Check out the workshop space well in advance.** You will need to plan the various activities in relation to the space, and probably rearrange the furniture. Make sure there is adequate workspace for participants to spread out and do their work that chairs are arranged to promote maximum interaction within each group, and that supplies will be accessible and well organized. Don't assume that the person who arranged for the space understands how you will use it. If the room is totally inappropriate, the only solution may be to request a different room.

We have arrived in a workshop area to find all of the chairs set up facing the front of the room, with little pads for note taking; and an overhead projector, podium and a pitcher of water at the front of the room! Because we arrived early enough, we were able to rearrange the furniture to make the room suitable.

On another occasion, we were ushered into a workshop space that was almost totally lacking in workspace, because computers, which were bolted down securely, occupied all the tables! This time, we simply had to ask for a different room.

Alternatively, the space design problem may be left to the teachers as one of the workshop activities. In this case, you should prepare for the workshop by arranging the room according to a deliberately *bad* design (See Chapter 5, “Designed Environments,” pp. 41 & 42).

2. **Collect the workshop supplies.** For each topic, these may include standard school supplies, discarded materials such as cardboard, and items you can borrow from home or school, such as nail clippers and hole punchers. While the total expense should be very small, you may need some time to collect enough of these items for the workshop. A suggested list of supplies for each topic is included in Chapter 5.
3. **Try out all of the workshop activities yourself, with children if possible.** There is simply no better way to guarantee that the activities will be doable within a reasonable time frame.

Once, in preparing for a Mechanisms workshop, we attempted to construct a model of an “automatic” sponge mop, using clothes hangers, cardboard, rubber bands and paper fasteners. After spending an hour-and-a-half on this project, we concluded that the problem was much too hard to use in the workshop!

4. **Contact the participants in advance.** It is important that they know what to expect from the workshop, and have some idea of what you expect from them. In addition, it is very useful for the participants to prepare for the workshop by spending a few minutes on a scavenger hunt. Each of the workshop descriptions in Chapter 5 (except Designed Environments) includes a suggested pre-workshop scavenger hunt.
5. **Conduct an Introductory Workshop.** Chapter 5 of this book begins with a description of the City Technology Introductory Workshop. This session, which can be conducted in as little as an hour, introduces participants to all five topics, and engages them in both analysis and design. Each group does a sample activity from one of the five guides, and then shares their work with all the participants. Some workshop leaders have used the Introductory Workshop as a recruiting tool for the half-day workshops, while others have used it to help participants determine which of the topics they would like to explore in further depth.



Introductions

At the very beginning, you should provide a brief overview of the workshop, and provide the participants with an opportunity to get acquainted. We recommend that the introductions include the following:

1. **Introduce yourself.** Describe your job briefly, and any experiences relevant to your current position, particularly work as a classroom teacher.
2. **Ask participants to introduce themselves briefly.** Each person might describe their teaching position, and any preliminary thoughts they have about attending this workshop.
3. **Set the tone.** Indicate that the group will be working with some new curriculum ideas, which were developed by college teachers and elementary educators in New York City, and field-tested around the country. Some of the teachers' stories can be found in Chapter 4 of each guide. However, these written materials are only a beginning, and there is no one "right way" to do *Stuff that Works!* Everyone is invited to contribute his or her own thoughts and experiences.
4. **Explain that in this workshop, everyone will learn by doing.** Most of the time of the workshop will be spent doing activities similar to the ones the students will be doing in the classroom. The time for the workshop is very limited, so the activities will be condensed here, but the basic ideas and approaches will be the same. The purpose of each activity is to explore some of the concepts and engage in some of the processes of technology. Knowing the "right word" for something is less important than exploring things thoroughly.
5. **Emphasize that technology includes far more than computers.** It consists of anything that people design and create in order to serve a purpose. *Stuff that Works!* focuses on everyday technologies that are familiar, and mostly available for free.
6. **Make your post-workshop expectations clear.** For example, the teachers may be participating in an on-line forum, documenting their classroom

projects, and/or attending a follow-up workshop. Clarify any such requirements at the outset; see also the sample letter in the Appendix, p. 79.



The Scavenger Hunt or Brainstorming

Session

We recommend that teachers and children begin exploring any topic by conducting a scavenger hunt or brainstorming session. Either of these activities is designed to engage them in searching for examples from everyday experience. A scavenger hunt collects physical artifacts, while a brainstorming session elicits examples from experience or imagination. Chapter 1 of each *Stuff that Works!* guide provides extensive suggestions on how a teacher can conduct a scavenger hunt or brainstorming session for herself.

Sometimes a full-blown scavenger hunt will fit into a workshop, but it is often not possible. Therefore, you may need to do your own scavenger hunt beforehand, so that you can display some examples of what a scavenger hunt might turn up. If the participants have also conducted their own scavenger hunts as a pre-workshop activity, this may produce additional items, but don't necessarily depend on them. A useful variation of the scavenger hunt is to include items that do *not* fit the category -- for example, for items that are *not* mechanisms or *not* maps. An excellent activity is to have participants later sort items according to whether or not they belong (see "Sorting," p. 17).

After they have examined the items you've provided, you might ask the participants to conduct a mini-scavenger hunt of their own. For example, in a Mechanisms workshop, participants can do a five-minute hunt for mechanisms in their own handbags, backpacks and/or briefcases. Similarly, a Packaging workshop might look for bags, boxes, containers, and other packaging items in the workshop area or nearby. A Signs, Symbols & Codes workshop could search the bathrooms, corridors, or elevators for graphic symbols; or examine the front and back panels of nearby computers, printers, and audio-visual equipment for icons.

A brainstorming session is like a scavenger hunt, except that the physical items are not readily available. The outcome of a brainstorming session is a list of examples. These may be examples of physical artifacts, or of intangible items, such as design

problems, design criteria or environments. If there is insufficient time even for a limited scavenger hunt, the participants could do a quick brainstorm instead.

In a workshop on Signs, Symbols and Codes, for example, we asked the participants, “Can you remember any of the signs and symbols you passed by on your way here today?”

In conducting a brainstorming session, it is important to write every idea down, without expressing any judgment, even if you or others do not agree that a particular item should be included. During “Sorting” and/or “Analysis” (see below) there will be opportunities to argue about controversial items on the list.

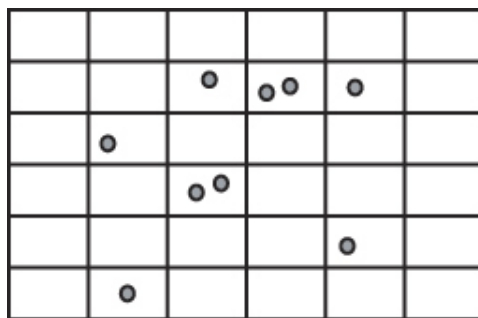

Sorting

Sorting is a first step towards the analysis of the examples from the scavenger hunt or brainstorming session. It involves creating categories that collectively include all of the examples, and then grouping the items according to category. The categories could simply be whether something does or does not fit the definition of the topic, e.g., *is* or *is not* a mechanism. At a more complex level, the categories could distinguish items according to function, mode of operation, material properties, user requirements, ability to solve a particular kind of problem, and many more. Inventing appropriate sets of categories is itself a worthwhile exercise, because it is a way to get at the structure of a larger set of items. We recommend a game we call *Guess my Categories!* It was invented by a fifth-grade special education student (Signs, Symbols & Codes, p. 89). Each group invents its *own* secret categories, and the others have to guess what they are.

In leading this sorting game, encourage the groups to come up with categories that reflect something basic about the items, rather than superficial characteristics such as size or color. As the categories are revealed, suggest other ways to categorize the examples. It is worth playing the game several times, so that participants get a sense of the full range of possibilities for sorting. This activity can easily lead to a discussion about the distinction between science and technology. Science categories tend to focus on the basic elements of a device, such as type of lever; while technology is more concerned with function and purpose, such as “things that cut” and “things that grab.” This point is developed further in Mechanisms & Other Systems, p. 12.

Analysis

The sequence of activities from brainstorming or a scavenger hunt, through sorting, to analysis, is a journey from the general to the particular. A scavenger hunt or brainstorming session looks at as broad a range of examples as possible. Sorting characterizes these according to a much smaller number of categories or subsets. Analysis looks much more carefully at one of these items, in order to understand its properties and method of operation. Some basic analysis questions are:

1. **What problems was it designed to solve?** In other words, what criteria does it have to meet in order to be judged a successful design? Alternatively, what evidence would tell you that it was or wasn't working? These questions require that you infer the designer's intentions based on the existing design.
2. **What are the elements of the design that contribute to its functioning?** This is the same kind of question that science addresses: What are the constituent parts of the design? For example, in analyzing a graphic symbol, you might look at lines, arcs, arrows, shapes, textures, colors, etc.
3. **How do the components work together to accomplish the goals of the design?** This question gets directly at the concept of a *system*, which is based on the idea that the whole is more than the sum of its parts. In some systems, such as a set of nail clippers, the constituent parts are easy to identify, and their interconnections are also fairly obvious. In more complex systems, like maps or furniture items, it can take more work to identify the component parts and their ways of interacting.
4. **How well does it work in accomplishing its purposes?** This question can be answered through a process of *product testing*, i.e., comparing the performance of alternative designs systematically. Because most designs have more than one purpose, product testing often reveals *trade-offs*: the design that works best to meet one goal may not be the best for addressing another. For example, a map that tells you how to get to a place may not portray the relative locations of places accurately.

This list applies well to analysis of existing products, but analysis of environments must often begin by defining the ways in which an existing design falls short. For example, everyone may have a vague sense that a classroom or cafeteria arrangement does not work well, but not know exactly why. Identifying the problems with an existing design can itself be a major analysis task. However, some shortcomings are more significant than others, and brainstorming alone cannot establish priorities. These can be identified by sorting the brainstorming list into categories such as "very important," "somewhat important," and "not so important." Subsequent analysis tasks may include listing additional information that is needed, collecting and organizing data,

and looking for patterns in the data. These kinds of analysis tasks are described in much greater detail in Chapter 2 of Designed Environments: Places, Practices & Plans.

Analysis activities draw upon most of the same processes as inquiry science: observing, making inferences, identifying variables, designing controlled experiments (fair tests), collecting data, searching for patterns, and presenting results. However, in the context of technology, these processes have an added twist. Science activities usually have well-established categories beforehand: the objects either sink or float; they either conduct electricity or they don't. In technology, the variables and categories of data are rarely specified in advance, so the activity calls for greater creativity and imagination. In the next chapter, we look in detail at two of the more difficult aspects of analysis, the control of variable and the use of quantitative data (pp. 29-33).

Design

Because design is so central to technology, it is important to include some design experience in any professional development workshop. However, a workshop may not provide enough time for participants to design, make and test something from scratch. Fortunately, there is a reasonable trade-off. There are several kinds of design activities that include major elements of design, but fall short of being full-scale design projects. These include:

1. **Redesign:** changing some, but not all of the characteristics of an existing design;
2. **Re-use:** finding a new purpose for an existing design;
3. **Modeling:** replicating an existing design using different materials.

These activities can be used to develop some basic ideas of design in a fairly time-efficient way. Generally, we have used modeling activities in Mechanisms workshops; redesign activities in Designed Environments workshops; and all three in Packaging workshops. Signs, Symbols and Codes and Mapping offer fairly rapid design cycles, which fit conveniently into a typical workshop.

Evaluation is an essential step in any design process, including the partial design projects listed above. Evaluation is really a form of analysis. It asks: *How well does the design meet the design criteria?* This is the same question that product testing asks; except that here it is about *one's own* design, while in product testing it was *somebody else's* design. Here are some examples of how evaluation might take place in workshops on each of the topics:

- Mechanisms: determining whether a cardboard model works the same way as the original mechanism;

- ❑ Packaging: testing a shopping bag (redesigned by adding handles to an ordinary paper bag) to see how much it will hold;
- ❑ Mapping: finding out whether someone can follow the map.
- ❑ Designed Environments: watching players of a redesigned game to assess how long it takes to win, how easy it is to learn, or how much interest it appears to generate.
- ❑ Signs, Symbols & Codes: seeing whether someone can follow a graphic instruction manual.

These design-and-evaluation activities are described in detail in the sample workshop agendas in Chapter 5.

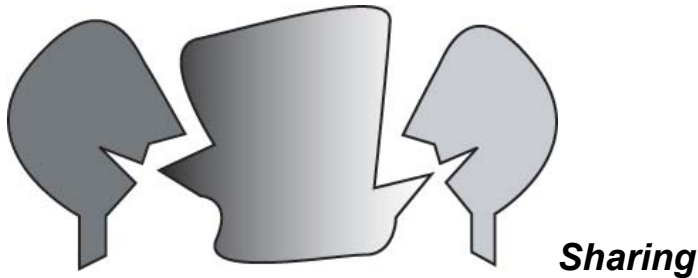

During a workshop, it is essential that the teachers share at least some of their work with the entire group. Sharing serves a variety of important purposes:

1. It provides motivation for the work, because participants generally like to show off what they did.
2. It provides an outlet for the enthusiasm generated by the activity.
3. It promotes cross-fertilization of ideas among the groups, and demonstrates that there are multiple solutions to a problem.
4. It provides opportunities for discussion, questioning, and reflection.
5. It allows teachers to recognize how language-rich the experiences are, and see the potential for language development.
6. It serves as a model for what should happen in the classroom.

There are a variety of ways to organize sharing. The most obvious method is to have each group come to the front of the room, one-by-one, and present their design or the outcome of their analysis. Some technologies that facilitate sharing are the chalk and blackboard, the marker and chart paper, and the overhead projector. The latter is

especially useful for demonstrating small artifacts such as mechanisms. If the device is placed on the glass surface, the audience will see it magnified in silhouette!

If not organized well, oral presentations can be very time consuming. At the outset, set some ground rules about how long each presentation should last. If a group has gone on too long, politely ask them to wrap up, so others can be heard too. Another strategy for saving time is to incorporate the participants' introductions with the first set of presentations. Just ask the group members to introduce themselves before talking about their work. If the number of participants is really large, it may not be possible for each group to share each activity. One possibility is for them to alternate: half the groups present the outcomes of one activity; and the other half presents the next one.

Formal front-of-the room presentations are not necessarily the best option. Some people find them intimidating to do, and it may be difficult for everyone to see and hear from various parts of the room. An alternative is to have each group present from its own table, as the other participants move around the room. Another possibility is to structure sharing like a science fair: half the groups are available at their own tables to present informally, while the other half circulate from table to table. Then they reverse roles. As an alternate form of science fair, some workshop leaders use "Gallery Walks" or "Poster Sessions," where each group organizes their data on their table or posts it on chart paper on a different section of the wall, and the participants move from location to location to view each presentation.

Reflecting on Classroom Possibilities

Near the end of a workshop, we recommend that you lead a brief discussion of what the experience has meant for the participants. Some focusing questions are the following:

1. How well would these activities work in your classroom? What sorts of modifications would you have to make?
2. What is their educational value? What goals might they be helpful in accomplishing?
3. In what ways do they meet standards, or other requirements?
4. How would you assess this work?
5. What barriers would make it difficult for you to implement these activities?
6. What strategies might be useful in surmounting these barriers?

Even a brief discussion of these and similar issues will both provide you with evaluation data, and also help participants develop a sense of the curriculum possibilities.



4. Thorny Issues

In this section we will tackle some of the more difficult issues that may arise in connection with *Stuff that Works!* and similar programs. Some of these may come up during a workshop, but they are more likely to appear later, during the period of classroom implementation. At the end of Chapter 2, we have already mentioned a variety of follow-up methods. These include additional workshops, informal telephone or Internet support, and the structured courses developed by the City Technology project.

The courses are designed to support teachers after the hands-on workshops, during the time they are working with students. Teachers who have participated in these forums have found them to be useful in several major respects:

- They provide opportunities for teachers to share ideas and experiences;
- They offer answers to specific technical questions; and
- They suggest instructional strategies for implementing *Stuff that Works!* in the classroom.

At the beginning of the next chapter, more detail is provided about the structure of the courses; later in Chapter 5, an outline of sample course work is provided for each topic.



What is “technology?”

In spite of any effort to inform them otherwise, some participants are likely to arrive thinking that the workshop will teach them about computers. At the outset, you may need to engage in a brief discussion of what “technology” includes, and why the workshop is *not* about computers (see “Introductions,” Chapter 3). There is nothing wrong with teaching children to use computers, which can be valuable tools in education. However, learning to *use* a computer does not mean learning about computer technology, any more than driving a car implies an understanding of automotive technology. Our view of technology education goes beyond the user level, to how the technology works, and how to design or redesign it. Computers are far too complex to be accessible to children, or even to many adults, beyond the user level. If computers were the sum total of technology, then technology would have to remain a mystery to most people.

Fortunately, there are many, many forms of technology that elementary-school children can analyze and design or redesign. Better yet, much of it is available for free or at very little cost. These are the technologies of everyday life, already familiar to everyone, and illustrative of the same principles as the more complex technologies that often claim more attention. For example, a shopping bag is a structure, just like a bridge is. Both can fail in compression, tension, or shear. Similarly, a robot is a mechanism, composed primarily of levers, which can also be found in a pair of nail clippers, an eyelash curler or an umbrella. Computers work by encoding information into a symbolic code, processing the coded information, and then decoding it. The basic principles of coding and decoding can be learned by studying graphic symbols, which can be found on street and wall signs, packages, appliances and other consumer items.

By focusing on technologies of everyday life, children can solve problems of real importance to themselves. The problems should include not only design or redesign of *things*, but also of *environments*, such as storage spaces, classroom procedures and cafeterias. Nearly everyone is short of storage space, confused by badly written instructions, and/or frustrated by poorly designed procedures. The definition of technology should include all of these, provided there is a systematic effort to analyze the needs and evaluate solutions. Technology need not be mysterious, expensive, irrelevant, or male-oriented (see “Technology and Gender,” pp. 33-34).

Definitions, and the demand for certainty

The word “technology” is only one of many that could be defined in a variety of ways. There are some who believe that they should not proceed with an activity until all of the relevant terms have been defined precisely. They will say, “Before we can decide which of these objects are mechanisms, you have to tell us exactly what you mean by the word.” Sometimes there are workshop participants who are happy to supply the authoritative definition. We disagree both with those who demand this kind of certainty, as well as with those who claim to have it.

There are *many* valid definitions of a word such as “mechanism,” “system,” “package,” “map,” “environment,” “technology,” “symbol,” etc., and each definition probably has its own strengths and weaknesses. A lively argument about what constitutes a map or a mechanism is far more valuable than a dogmatic statement about what it *really* means. Often, the most useful and understandable definitions are *operational*: they talk about what you have to do in order to make use of something. For example, an operational definition of *design* is: “to create something to serve a purpose, and to test it to see how well it works.” Somebody might object that this definition *doesn't* include things that really should be included, or *does* include things that shouldn't. This kind of discussion can lead people to explore and clarify some very subtle concepts, about which even experts disagree. The discussion should lead to revision and further refinement of the operational definition. Presenting an authoritative definition usually has the opposite effect. It puts an end to thinking, because now the problem has supposedly been solved. A definitive answer conveys the idea that knowing *exactly* what the word means is the real point of the exercise, when in fact it is largely irrelevant.

When participants become involved in this fruitless quest for certainty, do not hesitate to call “Time out!” Suggest that everyone try to suspend judgment about what the “real” definition may be. Words are only means to an end, not ends in themselves, and different definitions serve different purposes.

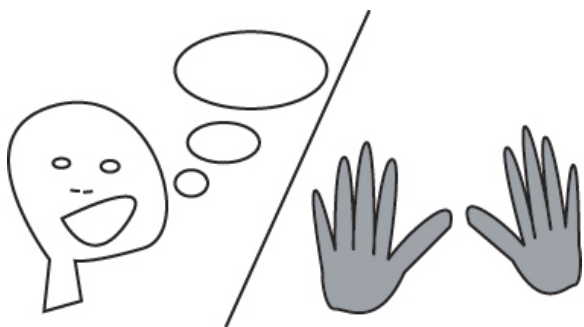

learning of concepts

Doing vs. Telling, and the

In the previous chapter, we outlined the major components of a typical workshop. There was no mention of direct instruction. Isn't some necessary? Do people learn entirely from experience, or do they also need some help in interpreting this experience?

These issues are equally relevant in the classroom. Just because someone has *done* an activity, doesn't mean that they have *learned* all they could from it. Usually, it is also important to present some of the ideas behind the activity, so the participants can reflect further on what it means.

Chapter 2 of each of the *Stuff that Works!* volumes contains an extended discussion of the concepts developed for and through the topic. In Chapter 5 of this document, we have included a synopsis of the concepts found in each guide. *We strongly believe that some of these concepts should be presented explicitly in a workshop.* The question is not whether, but how and when? Traditional instruction often falls short, because it presents concepts unconnected with one another, and remote from real problems and experiences. For this reason, we do *not* recommend opening a workshop with a statement of the major concepts and definitions. Until the participants have engaged in some of the workshop activities, they will have little if any context for understanding and assimilating these "big ideas." We *do* advocate the discussion of concepts later in the workshop, using the workshop activities to illustrate how these ideas connect with everyday experiences and artifacts.

Should this discussion of concepts be concentrated into a brief presentation plus demonstration, midway through the workshop? Or should it be conducted *ad hoc*, a little at a time, as appropriate to the issues and question that arise? At different times, we have used both approaches, depending on the topic, the time available, and size of the group. The *ad hoc* method seems to work best with smaller workshops, because there is more time to interact with each group, and address their discoveries and questions directly. Large workshops provide fewer opportunities for these interactions, making a formal presentation more necessary. The topics also vary in the nature of the "big ideas" that need to be developed. Mechanisms includes a well-established body of knowledge about types of motion, forces and levers. These concepts are well suited to a formal 15-20 minute presentation, employing as props the same devices the teachers have been studying. Designed Environments, by contrast, develops ideas about analysis and design processes, without much in the way of an existing knowledge base. We generally find it easier to address these ideas *ad hoc*. The other three topics fall somewhere between these two extremes.

In discussing concepts, it is important to recognize that teachers, like children, often hold ideas that are at variance with those accepted by scientists and engineers. Here are two examples:

In one workshop, teachers tested a tower they had built to see how much weight it could hold. As they added weight to the top, the tower became top heavy and toppled over. The teachers' analysis was that "It wasn't strong enough." These teachers had equated strength and stability.

Some teachers were attempting to model a flashlight circuit, including a battery, a bulb, and a switch. These teachers were familiar with science units like "Batteries and Bulbs," so they recognized that each terminal of the battery had to attach to a different terminal of the bulb. However, they did not realize that

turning a switch on and off has the same effect as connecting and disconnecting a wire. Instead of connecting the switch in series with the battery and bulb, they connected it in parallel, which drained the battery!

Unfortunately, little or no research has been done on teachers' alternate conceptual frameworks. In leading a workshop, be attentive to the teachers' thought processes, and the concepts that actually inform their work. Address their prior notions explicitly, or these conceptions are likely to persist. The discussion should make generous references to the examples that have already arisen in the workshop, and should be a give-and-take affair, with plenty of opportunity for discussion and debate.



What is Technological Design?

One of the “big ideas” of technology -- some would say *the* big idea -- is design. However, some popular conceptions of design are inconsistent with what we think it should mean in the context of technology. Here we will examine two commonly advanced notions, and contrast them with how we think about technological design.

“Design” is an important concept in art as well as in technology, but the word does not have the same meaning in the two fields. Some of what is called “technology” is really closer to art. For example, some students designed maps showing their “dream houses.” There is no way to evaluate such a design objectively, because such a house will never be built and tested. Besides, one person’s dream or fantasy may not necessarily appeal to someone else. Art is intended to express the artist’s own vision, and is evaluated by its emotional impact. The goal of an art project is to produce the image itself. In technology, on the other hand, the image is a means for solving a problem. In the case of a map, the problem is to convey information about physical space. For example, if a student designs a map of the classroom, showing how to get from one place to another, there is an obvious and simple test of the design: *Can another student follow it?* No such test can be made of a dream house map.

Another concept of design is expressed by the increasingly popular event known as a “design competition.” This is an exercise in which students are given a design task, and then work individually or in groups to construct a model that best meets the stated

criterion. A common middle school competition involves the construction and testing of model bridges. Each group plans and makes its own model, within some constraints. Then all of the bridges are tested by loading them until they fail. The bridge that held the most weight “wins.”

This type of activity certainly has the trappings of technology. There are artifacts, construction, measurement and recording of quantitative data. Nevertheless, we would argue that in most instances, the “bridge design competition” and similar competitive events *do not* qualify as technological design. Bridges are complicated structures, and students rarely have the time or the background to understand their operation well. Consequently, there is little or no analysis to inform the planning and construction phases. Their “designs” mostly likely mirror the superficial aspects of bridges they have seen. Furthermore, the evaluation of the bridges does not generally include an analysis of how they failed. Usually, there is no basis for redesign, or for learning more about how bridges work. Furthermore, these competitions usually provide only one criterion for evaluating the design. In any real design problem, there are multiple goals and often-conflicting criteria, which is the reason for making trade-offs. By focusing on only one criterion, the competition removes the problem from context. There is research suggesting that a focus on technical proficiency, out of context, contains a male gender bias. Similar observations might apply to other kinds of competitions, such as those involving robots, model cars, model airplanes, etc.

In our view, technological design implies that there are real problems to be solved and that any solution can be evaluated and probably improved upon. The dream house design, because it is never built, does not address real problems in the lives of the students. There is no objective evaluation of the design, because it represents a personal vision rather than a social solution. Similarly, nobody really needs a model bridge, and even if they did, the bridges are all broken by the time the competition ends. The evaluation does not lead to any insight about how it failed let alone how it should be redesigned. In contrast with these activities, a *Stuff that Works!* activity such as testing shopping bags leads to analysis of how and where each bag broke. Examination of failure modes points the way toward improvement of the design (see “The Role of Failure in Design”, later in this chapter).

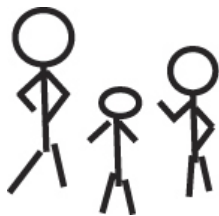

The group and the individual: getting the most from one another

Why should people work in groups? In principle, a group is like a system in that the whole is more than the sum of its parts. Each group member is supposed to bring his or her unique experiences and ideas to the task. Theoretically, group members not only

learn from each other, but also produce a better product out of their interaction than any group member could produce alone. However, as everyone knows who has ever worked in a group, it doesn't always work out that way! Often, there is one member who dominates, others who fail to participate at all, or quarrelsome individuals who fight with each other, while the others just watch. All too often, the benefits of collaborative learning exist more in principle than in practice, and some group members wind up wanting to work alone.

In one workshop, a male technology teacher was paired with two female third-grade teachers. He claimed to have extensive experience in the subject, and insisted on doing all of the workshop activities himself. Quite predictably, the two women were largely excluded from these activities.

How could this problem have been avoided? One approach is for the leader to set up homogeneous groups at the outset, but this idea has its disadvantages too. In heterogeneous groups, members can sometimes learn more from one another. Even in well-matched groups, a wide variety of group dynamics issues can arise. The most important thing is to be on the lookout for problems in group interaction, and to respond to them as they arise. It is usually obvious when a group is not functioning well. Voices rise, people tune out or even wander away, and some members have little to say during group presentations.

If a group is dysfunctional, your first inclination will probably be to tell them what you have observed, and suggest a remedy. This head-on approach is not usually effective in getting people to examine their own behavior. At worst, it may only generate denial, and resentment towards you. Rather than present your analysis directly, we recommend that you begin by asking the participants to examine *their own* behavior first.

To get the discussion started, it may be helpful to ask some focusing questions. If one or a few are dominating the group, you might ask, "Do you think each of you is participating equally in this group?" If two group members are arguing constantly, to the exclusion of everyone else, you could ask them, "How important is this discussion to the others in your group?" More specifically, you could remind them that the workshop has an educational purpose: "Do you think everyone in your group is learning something from this discussion?" It can be very helpful to make connections with the classroom: "What do you think is happening in this group? If you saw this pattern in your classroom, what would you think about it? What would you do?" As they discuss the problems, you can always add your own observations and conclusions, in the context of *their* discussion.

In other words, we are recommending that you handle group dynamics issues in the same way as technical content. Do not begin by telling the answers, but rather by encouraging the participants to tease them apart for themselves. By doing so, you can help the participants learn to address these issues as they arise in the classroom, and also help them to be better at working in groups. Learning to function in a group can be the most important lesson of all -- both for teachers and for students.



Process vs. Product?

Here are two sets of comments that are commonly heard by teachers and professional developers:

1. “I’m done. What should I do *now*?”
2. “I’m *not* done. I *can’t* move on to the next activity until I *finish* this.”

Although apparently opposite in meaning, both statements reflect the same basic position: that the purpose of the activity is to complete a product. But what makes something a product, and something else not? How important is it to “finish?” Or are only the process important, and not the product?

In our view, the apparent dilemma between process and product represents a false dichotomy in technology education. Not only are they both essential, but also they cannot really be distinguished as separate goals of an activity. Of course, students and teachers ought to become proficient in some basic processes, particularly design processes, which are central to the whole enterprise of technology. However, we know of no way to learn design in the abstract. Design is always design of *something*. A fundamental aspect of any design process is evaluation, or measuring the outcome of the process against the design criteria or goals. To perform an evaluation, you have to have something to evaluate. Therefore, completing some sort of product is an essential component of any design process. In technology, process without product is meaningless.

What about the reverse? Is it possible to have product without process? Certainly, products get fashioned in all kinds of different ways, often without much foresight, planning, or testing. Too much of the human environment is created through happenstance, rather than conscious design. Our goals are to *replace* as much as possible of the accidental or poorly conceived with *consciously* designed artifacts and environments that can be evaluated and redesigned if necessary. The whole point of teaching design processes is to advocate for a systematic, planned approach to the creation of new things and the solution of human problems. Products divorced from processes are at odds with the goals of technology education.

Although process and product are both essential ingredients in technology education, there sometimes does appear to be a trade-off between them. Here are two examples from teacher workshops:

1. *A group of teachers became deeply involved in making a table from discarded strips of pegboard. Their method was to weave these strips together with string. Because the table was fairly large, this weaving process was both repetitive and time consuming. As workshop leaders, we saw very little educational value to this activity. However, the teachers refused to scale the project down to reduce the amount of weaving. They claimed that to modify the project in any way would be to curtail their creativity and their desire to create this outstanding product!*
2. *In another workshop, a group of teachers was attempting to make a cardboard-and-paper-fastener model of a folding chair. In order to save time, we suggested that they make only the folding mechanism on one vertical side. The other side was exactly the same, and the seat and back were not essential to an understanding of the mechanism. However, the teachers insisted on making a model of the entire chair.*

Superficially, these two stories seem to express similar concerns, but we believe the issues in each case are very different. In the first one, the teachers were implicitly rejecting the goals of the workshop. They were genuinely involved in making something intricate and attractive, but were not particularly interested in evaluation or redesign. In their view, the completed table would speak for itself. Implicitly, they saw this as an artistic endeavor, rather than a technological design (see pp. 25-26). They regarded our suggestions as attempts to rein in their creative talents. The issue here was over conflicting views of process. Was the goal of the design process to create something esthetically pleasing and fun to make? Or was it to meet a set of design goals that included measurable functional requirements, such as the amount of weight it could support? The teachers took the former position, while we advocate for the latter.

The second case was different. There was no conflict here over the goals of the design process. The teachers were creating a cardboard model chair they would later test against the design criterion: it should fold and unfold in the same manner as the original wooden chair. The only disagreement was over what constitutes a valid product. For us, the basic folding mechanism on one side of the chair was sufficient, because it contained all of the information needed for understanding the entire chair as a mechanism. We felt that the remaining parts of the chair were redundant, and could easily be imagined once one had constructed the vertical side. The teachers did not share this view. They wanted to make the *entire* model in order to verify that it would work like the original chair. In retrospect, their position was a reasonable one. The teachers lacked our experience in 3-D visualization from a 2-D model, and therefore needed to make the entire model to see for themselves how well it worked. There was no argument over process, but there were different conceptions of the kind of product that would meet the process requirements.

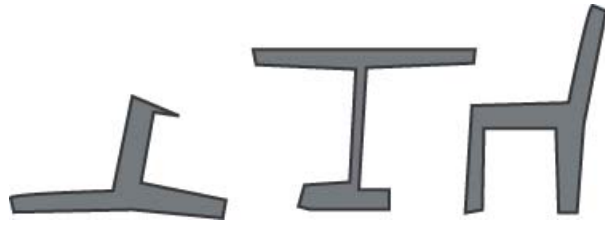

Design

The Role of Failure in

This issue is closely related to Process-vs.-Product. There is a strong desire – among both students and teachers – to get the right answer, and get on with the next task. This desire is an outcome of the position that there is one right answer, and the purpose of any educational activity is to find it. Furthermore, mistakes are seen as bad – in fact, something that can get you in trouble – and there is pressure to destroy the evidence of any “wrong answers” or, worse yet, bad designs.

As we see it, these points of view are obstacles to learning to do design. In any real design task, there is no one right answer. There are many answers, none of them perfect, because a real design needs to meet more than one criterion, and the design that addresses one goal well will inevitably fall short elsewhere. Balancing competing designs and criteria is a central process in design, called “evaluating tradeoffs.” Making tradeoffs is in itself a rich activity in problem solving. Sometimes it requires a redefinition or clarification of the conditions under which a product will be used. For example, the shopping bag that is strongest when dry may fail miserably when wet. In other situations, tradeoffs require setting priorities. In redesign of a classroom, it may not be possible to promote *both* small-group work *and* whole-class discussions effectively in the same design. Thus, it becomes necessary to decide which of these goals is more important.

Furthermore, design is an iterative learning process. The first effort to design something usually has serious shortcomings, because it is simply not possible to consider everything from a user’s point of view. What’s important is not how well the design works, but what happens next. There should be an effort to test the design honestly to determine its weaknesses. This process is called “failure analysis.” It suggests that a designer *expects* the design to fail in some undetermined way, and then examines the details of failure closely to find the shortcomings. This type of analysis provides clues for redesign based on *actual data*, not wishful thinking. Testing a design, and finding its weaknesses, provides solid evidence about what needs to change on the next go-round.

Within the prevailing culture, teachers and students often interpret design tasks differently. They think that the whole point is to “prove” that their design is “best.” For example, when they design a map to represent a route from one point to another, they can test it by seeing if someone can follow the map. There are two powerful tendencies during the testing process:

- ❑ the designer may try to “help” the tester with hints or gestures, or
- ❑ the designer may blame the tester for not understanding what “should be obvious.”

Neither stance is helpful for redesign of the map. It is far more useful to take note of the points where the map fails to do its job. These are the points that are calling for redesign.

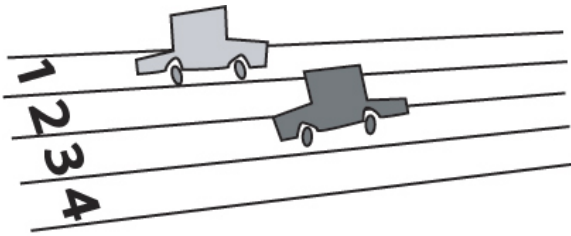

Controlled experiments, fair tests, and unfair advantages

An important goal of science education is that students learn to plan and perform a controlled experiment. Suppose you have the hypothesis that a plant will grow more rapidly if it is exposed to more light. So, you find some plants that are nearly identical, and put some of them on the windowsill, and others away from the window, and compare their growth rates. Sure enough, the ones on the windowsill grow more rapidly. Does this prove that more light makes plants grow faster? Not so fast! You notice that the windowsill is right next to the radiator, so the plants near the window received more heat as well as more light. From this experiment, there is no way of knowing whether the heat or the light caused the difference in growth rates. A controlled experiment might try to hold the amount of heat constant, and allow only the amount of light to vary between the test plants.

Controlled experiments are equally important in technology. Two situations that require control of variables are product testing and evaluation of alternative designs. First, let's consider product testing. Suppose you are comparing two shopping bags to see which one is strongest. The only variable should be the type of bag. If you held one of the bags by one handle, and the other by both handles, the test wouldn't be fair. Some other variables that should be controlled are how you put the weights in the bags, how long you keep them there, whether the bags are wet or dry, and any rocking or jiggling of the bags.

Similarly, a controlled experiment is needed to make a fair comparison of alternative designs. Imagine that students or teachers have designed a variety of cushioning methods for protecting a fragile object, such as a thin breadstick. One group has crumpled up newspaper for use as cushioning, another has sandwiched cotton balls in between sheets of foam rubber; still another group has used plastic baggies filled with air. Which of these methods is most effective at preventing the breadstick from breaking? To answer this question, an appropriate method would be to prepare a separate box with each form of cushioning. Then you could drop the boxes from increasing heights, examining them each time to see if the breadsticks were still intact. In this experiment, the only variable should be the cushioning method. It wouldn't be a fair test if different-size boxes were used, or if some boxes were dropped on a rug instead of a bare floor, or if one of the boxes was thrown down hard, while another was allowed to drop gently.

Although humans develop an acute sense of social fairness very early, the principles of a fair test, and control of variables, are not at all obvious to most children or adults. A classic error in teaching these concepts is to assume that a few minutes of explanation will be sufficient. We have seen science fair assignment sheets where very young students were supposed to list the variables they controlled and the variables they were investigating, without any understanding of what any of this really meant. The ideas behind a controlled experiment are developed with great difficulty if at all. Many adults still don't really grasp these ideas, and children necessarily develop them over time.

We believe that control of variables should be taught as the solution to a problem. Simply *telling* teachers (or students) to control variables is generally ineffective, because they are being told the solution before becoming aware of the problem. In other words, we advocate that teachers or students be made uncomfortable with the outcomes of an *uncontrolled* experiment, before they are introduced to the solution to this problem: the *controlled* experiment. A simple demonstration can be a way to start this process. Announce that you are about to test the “bounciness” or elasticity of two different kinds of rubber ball. The one that bounces higher will be deemed the more elastic. Then go through the following (comedy) routine:

1. **Unequal distances from the floor:** Drop one of the balls from the highest level you can manage, and drop the other from close to the floor. The one that drops from a greater height will almost certainly bounce higher, so declare it the winner. “But that’s not fair!” someone will complain. “You have to drop them from the same height!”
2. **Both balls do not reach the floor:** Then hold one of the balls over the floor, and the other over a desk or table and drop them both from the same height off the floor. The one that bounces off of the desk will probably bounce higher (relative to the floor), so declare it the most elastic. Again there will be an outcry. “No, no. You have to let both balls hit the floor. What you did still isn’t fair.”
3. **Balls dropped onto different kinds of surfaces:** Take out a cloth towel and spread it on an area of the floor. Drop one of the balls onto this soft surface, while the other drops onto the bare floor. The latter will definitely bounce higher. By now, they are probably catching on to the joke that is being played on them. “Get rid of that towel,” they will say. “You can’t compare the balls, if you drop one of them on a surface like that.”
4. **Different launch methods:** This time, remove the towel, drop both balls onto the floor from the same height, but *throw* one hard, while letting the other simply drop. By now there should be no question at all about the point you are making.

This demonstration is easy and immediate, but not everyone will translate it into practice. As a follow-up, we have sometimes taken the problem-based approach one step

further. We set up an experiment for teachers to do, offering no guidance at all about control of variables.

In one workshop, teachers tested spray dispensers in an uncontrolled manner. They leaned a board against a wall and filled the dispensers with liquids of different viscosities, such as water and oil. To test the pumps they simply squirted the liquids onto the board, but could not compare the spray dispensers, because they failed to control several of the variables that might affect the results. They didn't standardize the type of fluid, the angle of the nozzle, the distance of the nozzle from the board or the height of the nozzle from the ground. Based on this experience, however, these teachers quickly realized what they would need to do to set up a fair test.

How does a teacher's understanding of controlled experiments translate into work with students? Just like teachers, students will need to see the problem of uncontrolled variables for themselves. Activity #3 in Packaging & Other Structures includes an introduction to fair testing for lower-elementary-grade children. It is similar to the test of elasticity described above, in being a demonstration, rather than an open-ended activity. Activity #8, in the same guide, is intended for the upper grades. Like the spray dispenser activity described above, it is a deliberately uncontrolled experiment, whose purpose is to highlight the problem of uncontrolled variables. These two approaches are designed to respond to different developmental levels; see "Developmental Issues," pp. 35-36.

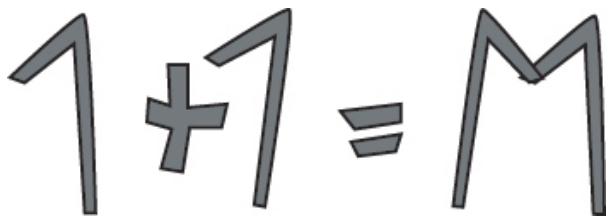

Math Avoidance and the Case for Quantitative Data

Like most adults, many elementary school teachers believe that they "are not very good at math." There is a general belief that you either have a "gift" for math, or you don't; and if you don't, there is not much you can do about it. Even more than other subjects, math is often seen as a necessary evil: something that has to be taught, but not necessarily understood. All too often, math is presented as a set of procedures to be memorized, "needed" to solve test problems of no particular significance aside from the test. Teachers who have learned math this way are likely to pass these negative attitudes on to their own students.

The irony is that most people are far *better* at doing math than they realize. A study by anthropologist Jean Lave showed that supermarket shoppers used sophisticated methods for doing price comparisons. These methods were very different from the procedures they had learned in school. Asked to solve the *same* sort of problem in a traditional paper-and-pencil-exam setting, these shoppers were stymied, as they tried and

failed to remember the old school-math algorithms. Similar outcomes were revealed in studies of how people handle family finances; measure diet portions, and negotiate in public markets. When the outcome of calculation is important, there is a real incentive to check one's work, refine the method, and re-do the problem if necessary. Attached to a significant problem in one's life, math actually becomes useful, and most people become fairly proficient at it.

As a result of math avoidance, teachers in a workshop will often perform an investigation, but resist collecting numerical data. Pressed to make quantitative comparisons, they will say something like, "I'm not much for numbers, but can't you see how much better this one works than that one?" The best answer to this question may be, "No." Patterns often remain hidden until there are numbers attached to them. Quantitative data reveals these patterns. Here are two examples from classroom interruption studies:

A third grade class did a study of interruptions by visitors to the room. Each interrupter was assigned a different bar on a horizontal bar chart. Every day an "interruptions monitor" had the task of adding a square to the appropriate bar any time the class was interrupted. One day, the principal came in and noticed that the longest bar had her initials next to it, and that a child had just added another square to the bar. The interruptions soon stopped.

A teacher created a pictogram showing public address system interruptions in his classroom over several weeks. He noticed that there were far fewer interruptions on Fridays than on other days of the week. The explanation soon became clear: Friday was the day of district-wide principals' meetings, when the principal was out of the building most of the day.

These examples highlight not only the value of quantitative data, but also the need to present it so the patterns are revealed. In traditional math education, graphing methods are presented as a variety of techniques to be learned for their own sake. However, in any particular situation, one type of graph may reveal the patterns more clearly than another, or be easier to construct and use. The choice of a graph type and construction of a graph should be subject to evaluation, and perhaps redesign. In other words, finding an effective way to present data is itself a design problem! One teacher suggested the development of "Graphing Process" along the same lines as "Writing Process."

Stuff that Works! offers rich contexts for doing and using math. For example, students who are redesigning their own classroom really do need to know the size and shape of each piece of furniture. By performing the analysis quantitatively, the design can be improved dramatically. Measurement and calculation are not ends in themselves, but means of solving problems more effectively.

Teachers should be encouraged to be as quantitative as possible in their collection, analysis and presentation of data. Of course, they will ultimately learn this lesson best by discovering it for themselves. If one group collects quantitative data, and others don't, call attention to the differences in how much one is able to learn in each

case. Similarly, when groups present graphs, charts and tables, help the teachers compare their own data presentation methods. Which ones best highlight the meaning of the data?

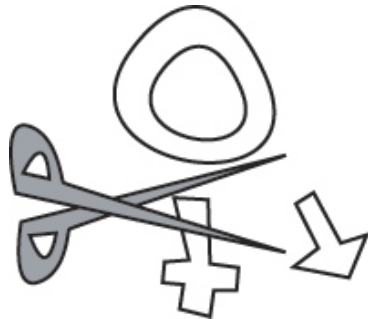

Technology and Gender

An obstacle to the study of technology by girls is the belief that it is primarily a male endeavor. This belief takes many subtle and not-so subtle forms. Teachers - both male and female - may feel that the girls in their classes will not relate to technology as well as boys. Female elementary school teachers may feel marginalized by male teachers who claim to be experts (see “The Group and the Individual,” pp. 25-26). Some technology programs may perpetuate these ideas by focusing on topics or activities that are implicitly gender-biased. How can technology be made equally engaging for both boys and girls?

Contrary to a common misconception, technology has probably never been primarily a male pursuit. Men may have been more involved in hunting, metalworking, construction, and military technologies, but there are also many vital areas of technology where women have taken the lead. These include the techniques of food preservation, dyeing, sanitation, protection from heat and cold, agriculture, animal husbandry, and housing maintenance. These technologies are at least as important to human survival as those more associated with men, and certainly as demanding intellectually.

Our technological society depends to a remarkable extent on technologies that are rather mundane, and not at all exotic or “high tech.” Just think of the myriad articles of clothing, furniture, linen, kitchen utensils, writing implements, fasteners, packages, signs, and symbols that frame everyday life. Furthermore, most people are hobbyists or enthusiasts of one kind or another. They enjoy photography, gardening, furniture restoration, gourmet cooking, pet care, sewing, sketching, audio, model making, and many other leisure-time pursuits. Immersion in each of these activities requires an intimate knowledge of a specialized area of technology. Most people -- both men and women -- are more involved with technology than they realize. Experiences with these and many other pursuits make nearly *everyone* knowledgeable about technology.

Stuff that Works! provides abundant opportunities to draw on people’s lifelong experiences with technology, as background material for a more systematic study of the subject. Nobody is excluded, because everyone has had these experiences. Of course, there are also concepts to be learned, and some people may be more familiar or

comfortable than these with others. This is most true of Mechanisms & Other Systems and Packaging & Other Structures. However, by tying the concepts to familiar artifacts, these concepts can come alive for everybody. In other topics, especially Designed Environments, there is virtually no organized body of knowledge, and nearly all of the background material comes from everyday experience.

In designing a professional development program, it is important to be aware that the artifacts, problems, and examples you choose may resonate more with males than with females, or vice versa. Our approach is to select as wide a variety as possible. In selecting materials for a workshop on Mechanisms, for example, we generally try to provide a broad spectrum of devices, including eyelash curlers and ice cream scoops as well as vise grips and tin snips.

There is some research suggesting that males differ from females in how they approach a problem involving technology. According to these findings, males attempt to attain technical proficiency, while females are prone to look at the problem in its broad human context. If this is true, *Stuff that Works!* should appeal to females. It is strongly oriented towards a holistic approach to technology, particularly in the guides Designed Environments and Signs, Symbols & Codes. In preparing teachers to work with *any* of the topics, it is very important to encourage discussion of how technology works in its social context. For example, in Packaging workshops, participants often wonder why shopping bags from clothing stores are so much stronger than grocery bags, although groceries are typically much heavier than clothing!

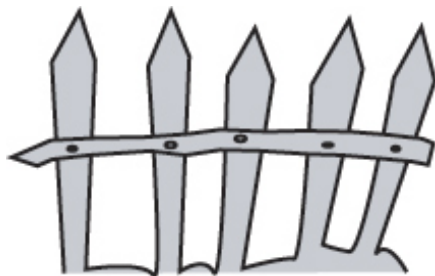

Making it work: negotiating barriers

A common reaction of teachers to *Stuff that Works!* is something like: “My kids would really love this, and so do I, but I’ll never be able to work it in with everything else I’m supposed to do.” Teachers who make this sort of claim definitely have a point. They really are called upon to meet an extraordinary list of demands, some of them contradictory. It is reasonable for them to be wary of yet another set of things to do, appealing as those might be. Nevertheless, many teachers have figured out ways to implement *Stuff that Works!* in their classrooms, occasionally as a standalone subject, but more often integrated with math, science, social studies and/or language arts.

At some point during a workshop, it is important to hear teachers’ qualms about the difficulties of implementing *Stuff that Works!* in their classrooms. There are several ways to answer these reservations and objections. Chapter 4 of each guide, *Stories*,

includes accounts by several New York City teachers of what they did in their own classrooms. However, these stories may not answer the specific questions of teachers working in very different settings. It is generally more helpful to hear from others who are working under similar circumstances. If you have tried some of these activities with children, you might use examples from your experience, emphasizing the strategies you used to overcome the obstacles. If other teachers in your district or locality have already implemented *Stuff that Works!* in their own classrooms, it can be very helpful to invite them to the workshop to present their experiences.

In case experienced teachers are not available, there are some general suggestions you can make. Nearly every *Stuff that Works!* activity can be integrated with language arts. Chapter 5 of each book includes a list of children's literature that is related to the topic of the book. Many teachers have introduced a topic by reading, or having students read a relevant story. A *Stuff that Works!* unit usually begins with a brainstorming session or scavenger hunt to find examples of the technology. A brainstorming session is also an exercise in oral communication and discussion. Students should keep written records of their scavenger hunts, sorting activities, analysis, modeling, and design. Often they will want to present this work orally as well. Sometimes, groups have to figure out how to interpret data, or negotiate over alternative design ideas. These discussions provide further practice in oral communication. Some teachers have also provided evaluation forms for their students to assess their own and one another's work. There are so many opportunities for oral and written communication that some teachers have used *Stuff that Works!* primarily as a vehicle for teaching literacy, rather than with the goal of teaching technology concepts. See, for example, the work of Mary Flores in every guide except Packaging, the accounts by Kathy Aguiar in Mechanisms and Signs, Symbols & Codes, and the story by Verona Williams in Packaging.

If teachers are concerned about meeting standards, you might refer them to Chapter 6 of one of the *Stuff that Works!* books, which describes how the material in the book addresses standards in math, science, technology, language arts, and social studies. Each of the activities in Chapter 3 also includes standards references. However, the references in both chapters are to national standards, which may not be those of greatest concern to teachers and administrators. References to selected state standards will soon become available on the City Technology web site.

Perhaps the trickiest issue is dealing with building administrators. More traditional-minded principals, not used to active learning environments, may be put off by the apparent chaos of a technology activity. Administrators may also feel pressure from parents and/or district-level officials. The best solution we have found is to invite the administrators to participate in a workshop, so they can experience the value and power of the activities firsthand. Additional suggestions can be found in "The Institutional Context," which is in Chapter 5 of every teacher guide except Mechanisms.

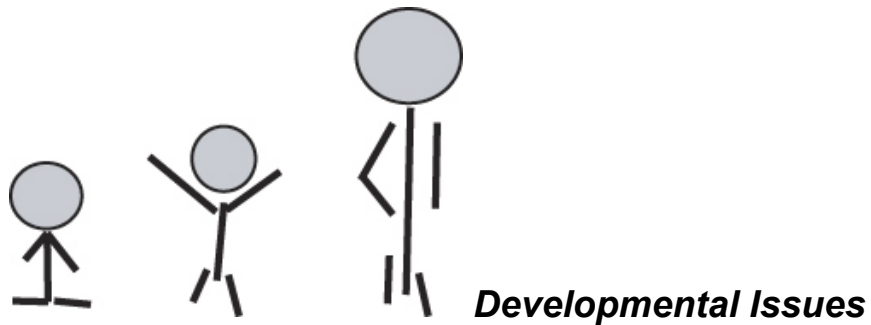

Is it age appropriate? In thinking about using a new activity or curriculum, teachers will naturally wonder whether their students are developmentally ready. We have found it difficult to generalize about developmental levels. In the US, very little research has been done about how children learn technology, particularly how they come to understand core concepts like *system*, *control*, *model*, *tradeoff*, or *design*. As a result, knowledge of cognitive development is largely anecdotal.

In several of the *Stuff that Works!* materials, the activities are categorized as “Introductory,” “Intermediate,” or “Advanced.” Each activity also includes a suggested range of grade levels. The activities we call “Introductory” really serve different purposes with the lower and the upper elementary grades. For younger children, these activities will probably constitute an entire unit, requiring several class periods to do thoroughly. For older elementary children, the same activities may last a period or less, and serve as the introduction to an extended unit consisting mostly of more advanced activities.

Here are two examples of how developmental questions have arisen in the context of work on Mechanisms:

First graders were challenged to model a pair of scissors using paper fasteners and paper. They had to solve such basic problems as how to use the hole punch, where to put the hole, where to put the paper fastener, how to fold the ends so it wouldn't fall out, etc. None of this was obvious to them, as it would have been to older children. The teacher wisely refrained from giving them the answers, and eventually they resolved these problems. (Mechanisms, pp. 118-121)

Fourth graders, who were solving “mystery mechanism” problems, wanted to go right to work with cardboard, without drawing up their plans first. Their teacher would not permit them to begin cutting cardboard until they presented their “blueprints.” She wanted them to learn planning, and was also interested in how well they would be able to translate their plans into models.

A classic developmental issue concerns children’s readiness to control variables (see “Controlled experiments, fair tests, and unfair advantages,” pp. 29-31). It is generally accepted that the concept of a controlled experiment is not developmentally appropriate until at least the upper elementary grades. However, younger children *can*

begin to grasp some of the ideas leading to control of variables, and it is important that they do so. With a little prompting, they can detect that a test is “unfair,” because the same conditions are not used in each case. An example is provided in Packaging & Other Structures (p. 105): Second graders were able to see that comparison tests of shopping bags were invalid unless the same type of weight was used in each bag.

Because these kinds of developmental issues have barely been studied, teachers who use *Stuff that Works!* have to feel out their way, often adjusting their approaches, backtracking, or figuring out how to do it better next time. The work of these teachers points to our most important conclusion: there is no substitute for ongoing monitoring of what students are learning. This monitoring ought to take many forms, which are described in the section on “Assessment” in Chapter 5 of each of the *Stuff that Works!* guides. Ongoing assessment will usually provide the only reliable information about students’ developmental readiness for *Stuff that Works!* activities.

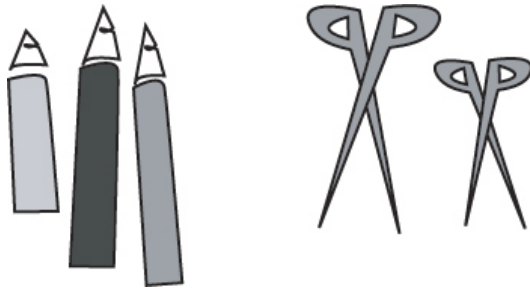

5. Resources Overview

In this chapter, we begin by describing an Introductory Workshop, which professional developers have used to recruit workshop participants, provide an overview of City Technology at conferences, or use as a warm-up for an extended series of workshops. The Introductory Workshop can be completed in an hour to two hours, and provides a nice overview of our view of technology, as well as a glimpse of each of the five topics. The remaining sections of this chapter outline professional development experiences for all five City Technology topics. In each case, professional development is based on a three-hour workshop, which is intended to prepare teachers to implement the topic in their own classrooms. Additional support can be provided through on-line or in-person courses, which are also described in this chapter.

The Introductory Workshop consists of a series of Design/Technology Brainstorming/Scavenger Hunts, a Smorgasbord of activities from each of the five books, and a sharing session that acquaints all participants with all five Smorgasbord activities. These are described in detail on pp.

In the major sections of this chapter, we present extensive workshop plans for each of the five *Stuff that Works!* topics. For each topic, the description includes the following:

- ❑ **Summary of Key Concepts:** A brief outline of the basic ideas from Chapter 2 (“Concepts”) of the associated teachers’ guide.
- ❑ **Pre-Workshop Scavenger Hunt:** Directions for a simple scavenger hunt that participants can spend a few minutes doing at home or school beforehand.
- ❑ **Workshop Materials:** A list of materials needed for conducting the sample workshop. These are generally available at little or no cost.
- ❑ **Directions to Participants:** This section consists of a set of instructions for each activity, suitable for copying to transparency films, PowerPoint slides, or chart paper, for use during the workshop.
- ❑ **Sample Workshop Agenda:** A plan for a typical three-hour workshop. Each one follows the generic outline in Chapter 3, but is developed in detail, and focused on the particular topic.

- **Workshop Tips & Strategies:** Here we offer rationales for the workshop activities, and suggestions for getting the most out of them.



Introductory Workshop

Overview

This workshop serves both as an introduction to the City Technology curriculum ideas, and as an engaging way of recruiting teachers to participate in the more extensive workshops described later in this chapter. The opening segment consists of a series of “brainstorming/scavenger hunts”, which are intended to highlight the range of things in that qualify as “technology” and the myriad of everyday experiences that are examples of design. The scavenger hunt is followed by five self-guided activities, one from each topic, which five groups perform in parallel. In the course of these activities, each group engages in an activity from one of the five topics. In the concluding sharing session, participants introduce each other to all five topics.

Workshop Materials

General Supplies

- ❑ Overhead projector & transparency films or flip chart
- ❑ Markers

Mapping

- ❑ Two sets of checkers games; these can be home-made using two 8 x 8 large grid sheets, and 24 cardboard or construction paper playing pieces of each of two colors, preferably red and black (12 of each color per set). Create a checkers board by coloring alternate squares black.
- ❑ Large cardboard box (as shield to prevent the sides from seeing each others’ games)

Designed Environments: Places, Practices & Plans

- ❑ Graph paper with large grid squares, about 1 in. wide

Packaging & Other Structures

- ❑ Two or three small, irregularly shaped objects at least 2 in. per side, and no more than 4 in. on any side, such as wind-up toys, small appliances, coffee mugs, etc
- ❑ Butcher paper, large sheets of construction paper and/or large file folders
- ❑ Assortment of boxes that can be folded completely flat, and assembled without tape or glue; these are used, for example, to package computer keyboards, rolls of pennies (from the bank), and some office supplies. (If these are not available, the activity can be modified slightly to use boxes that have *one side seam glued*, but otherwise open and close completely without tape or glue. In this case provide a roll of masking tape.)

Mechanisms & Other Systems

- ❑ Several hole punchers
- ❑ Several pairs of scissors
- ❑ Thin cardboard (discarded cereal boxes, file folders or express mail envelopes)
- ❑ Brass paper fasteners, 1 or 1 1/2 in. length
- ❑ Assorted rubber bands, of varying lengths and widths
- ❑ A variety of two-dimensional linkages, suitable for modeling. These should each include more than one lever, and operate mostly in a plane. Examples include a pair of tin snips, a vise grip, a tea-bag strainer, pizza tray holder, and some types of garden shears (see photo below)



Mechanisms for modeling

Signs, Symbols & Codes

- ❑ Deck #1: Eight index cards, each with one of the images taped or glued to it
- ❑ Deck #2: Eight index cards, with the same images plus explanations attached
- ❑ Deck #3: Blank index cards

NOTE: Images for Decks #1 & #2 are available on the next four pages.

Signs, Symbols & Codes – Deck #1

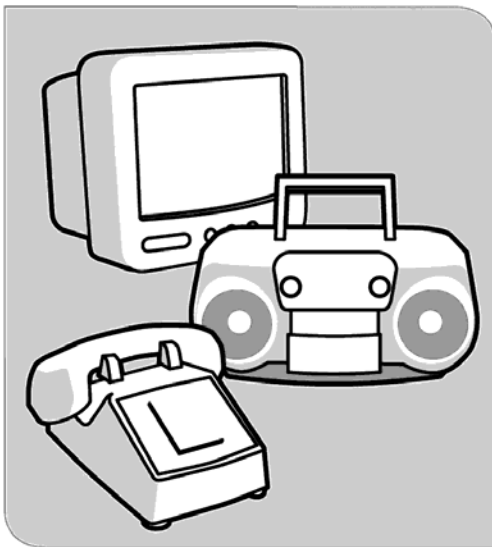
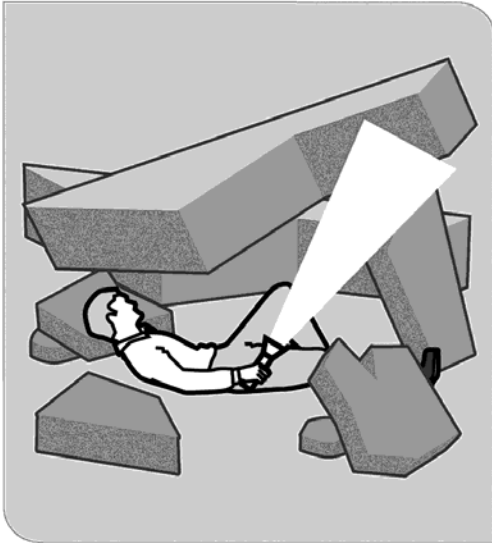

Signs, Symbols & Codes – Deck #1, Continued

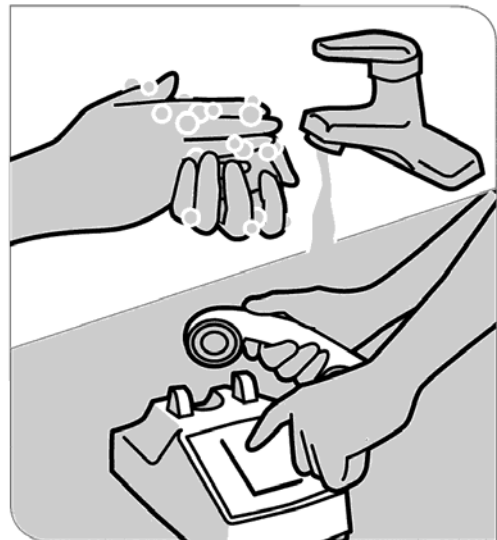
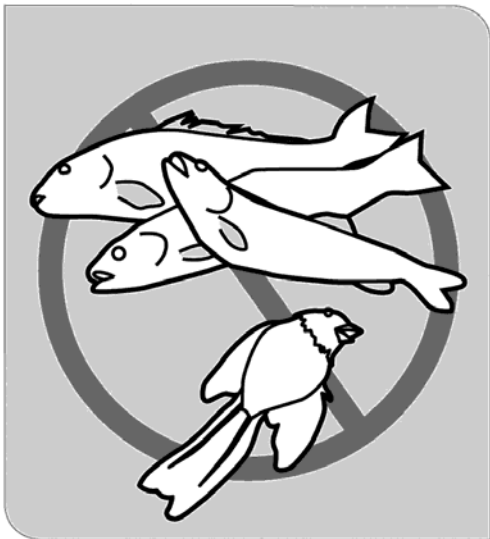

Signs, Symbols & Codes – Deck #2

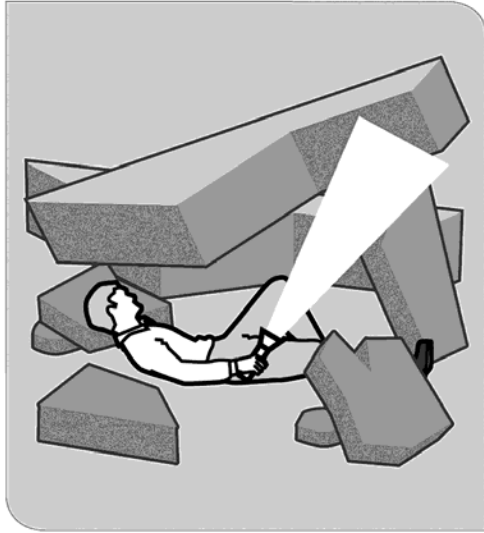

1. If possible, use a flashlight to signal your location.



2. Avoid unnecessary movement so that you don't kick up dust.

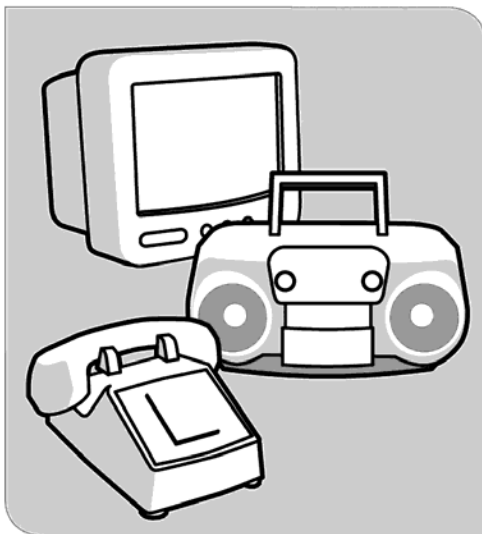

3. You will probably learn of the danger through an emergency radio or TV broadcast.



4. Use the back of your hand to feel the lower, middle, and upper parts of closed doors.

Signs, Symbols & Codes – Deck #2, Continued



5. If you catch fire, do not run!



6. Do not go back into a burning building and carefully supervise small children.

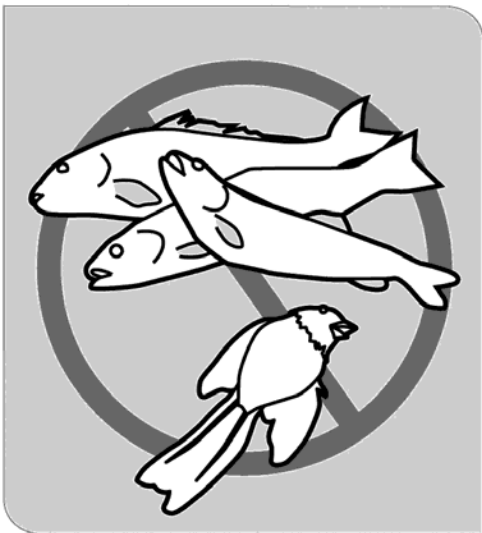

7. Many sick or dead birds, fish or small animals are also cause for suspicion.

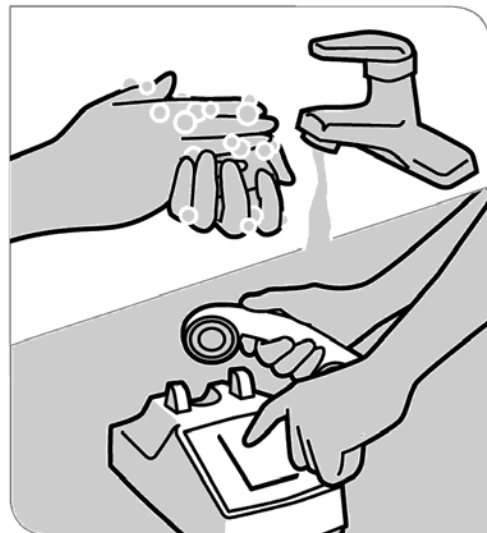

8. Wash with soap and water and contact authorities.

Directions to Participants

The next five pages provide a set of instructions for the Smorgasbord activities. One of these pages should be made available to each group. It can be mounted in a picture frame or on an open file folder, and placed on the table. As much as possible, each group should be given a different activity.

MECHANISMS & OTHER SYSTEMS

Careers in Modeling

1. Select a mechanism.
2. Make a model of it, using cardboard and paper fasteners. Use a rubber band to model a return spring, if there is one.
3. Compare how the original mechanism and the model open and close. Redesign your model to correct any differences.

SIGNS, SYMBOLS & CODES

Symbolic Disasters

1. Begin with Deck #1. Write down what you think each symbol means.
2. Turn over Deck number #2. It shows the meaning of each symbol, according to the U.S. Department of Homeland Security.
3. Use the blank cards in Deck #3 to invent a better symbol (using no words) for one or more of the messages.
4. Show the symbols you've created to members of another group to see if they can figure out their meaning. Listen carefully as they try to interpret your symbols. **NO COACHING!** Find out what features of your symbols are ambiguous or unclear.
5. Use the information from the testing of your symbols to redesign them. Then try them out again, to see if they work better!

DESIGNED ENVIRONMENTS

Tactic Toe

1. Play the game of tic-tac-toe a few times. Discuss the experience: what do you dislike about it?
2. Make one change in the way the game is played, for example, in the design of the board, the definition of a “win,” or the sequencing of moves. Play it a few times using the new rules, and see what happens.
3. Decide on a criterion for how you would like the tic-tac-toe experience to change.
4. Develop new rules that you think might accomplish this goal.
5. Explain your new rules (but not the criterion) to members of another group. Ask them to play the game using the new rules, and describe the experience. Did it meet your design criterion?
6. Redesign the game to meet the criterion.

MAPPING

Blind Checkers

1. Divide the group into two “teams,” each of which will be one “side” in the same game of checkers. Because the game will be “blind,” each side will need its own board to keep track of the game. Place the box in the middle of table so each side cannot see the other side’s game board.
2. Each side should set up its board with 12 pieces on each side, and decide who will be “black and who will be “red.”
3. Because the game is blind, both sides have to agree on a method for keeping track of each move. Play a few moves, and then compare boards.
4. Revise the method as needed, based on the outcome of #3, and repeat until both game boards consistently look the same. Keep a record of each method you used.

PACKAGING & OTHER STRUCTURES

Thinking out of the Box

1. Several boxes are provided on your table. Each of them can be laid flat and is made from a single sheet of cardboard with at most one side glued. Look carefully at how they fold up and flatten out. Compare the different ways these various boxes work.
2. Select one object for packaging. Based on the designs of the fold-up boxes, make a box for your object out of heavy paper. Use tape on no more than one side.
3. Make another design, based on a different fold-up box. Compare the designs. List the pros and cons of each one.

Preparation of Workshop Space

Set up materials for each of the five Smorgasbord activities on one of each of five tables. Using a file folder or self-supporting picture frame, display the directions for the activity at that table (see preceding five pages). To avoid distracting participants, you may want to hide the instructions and supplies during the Design/Technology Scavenger Hunt.



Sample Workshop Agenda

Design/Technology Brainstorming/Scavenger Hunts and Introductions (10 – 30 minutes)

Begin the workshop with as many as possible of the following brainstorming and scavenger hunt activities. These come in two categories, and it is useful to select at least one from each category. They should be conducted one at a time. In each case, ask each group to do make a list collectively, and then have one or more group member share the list with the entire workshop. The first sharing session is a good occasion for all the group members to introduce themselves.

Technology Brainstorming/ Scavenger Hunts:

- ❑ Make a list of examples of technology that you can find in this room.
- ❑ Make a list of examples of technology that you brought with you today.
- ❑ Make a list of examples of technology that could be found in your classroom.

Design Brainstorming/ Scavenger Hunts:

- Make a list of design problems that have come up in the course of your hobbies.
- Make a list of design problems that you address as a teacher.
- Make a list of design problems that students have addressed in your classroom.

Smorgasbord (40 – 60 minutes)

Each group has already been provided with a complete set of instructions and materials at their table (see preceding 5 pages). Explain to each small group that they will have about 45 minutes to work on their task, and then they will be reporting to the entire group. After about 30 minutes, remind each group that they will need to prepare a report to the other groups.

Sharing & Discussion (10 – 30 minutes)

Each group reports briefly on what they did and what they learned. Sharing is followed by a whole group discussion of how these activities would fit in a classroom, including learning goals and addressing of standards.

Workshop Tips and Strategies

Design/Technology Scavenger Hunt

The goal of this activity is to highlight the facts that “technology” includes most of the items that surround us, and “design” is something we do frequently, every day. Avoid trying to define either term. Suggest that they come up with examples first. Encourage debate over particular items from the lists. Some participants may insist that “technology” includes nothing but computers, LCD projectors, cell phones, etc. Ask when these items were invented, and inquire whether there was any kind of technology before that. If participants have difficulty thinking of design activities, encourage them to think of occasions where they had to plan something in advance, or in which children identified classroom problems and suggested solutions.

Smorgasbord

Mechanisms & Other Systems

Encourage the group to look very closely at the moving parts and pivots that make up the mechanism they have selected. They will need to reproduce each of these in their model. A simple method is to trace out each part on a sheet of cardboard, indicating the locations of the pivots. Then they can cut out the pieces, punch the holes for the pivots, and assemble the model. Most of the devices have return springs, which can be modeled using rubber bands, but there is an important difference. Most return springs are made of metal, and operate in compression. In other words, they resist the force of pushing. Rubber bands, on the other hand, operate only in tension: they resist when pulled.

Deciding how and where to attach a rubber band, to create the return spring action, can be an interesting challenge. In evaluating the model, here are some questions to ask:

- ❑ Are the directions of motion of the inputs and outputs the same in the model as in the original?
- ❑ Is the range of motion similar in both?
- ❑ If the device returns to its original position when released, does the model do so too?

Signs, Symbols & Codes

The most important phase of this activity is the testing of the newly designed symbols. It is likely that at least some of the symbols will fail to convey their messages. The purpose of these tests is to collect the data needed to redesign the symbols to make them more effective. Some participants will have a tendency to “help” the testers “get the right answer,” while others will blame the testers for not understanding a symbol they consider obvious. Both of these reactions misread the central purpose of this exercise. The test is of the symbol design, not the testers, and the weakness of the existing design is vital information (see “The Role of Failure in Design,” Ch. 4). Encourage the designers to note carefully the components of their design that the testers can’t make sense of or that they misinterpret. By observing closely how the design fails, participants will collect the data they need to improve upon their first design.



Designed Environments: Places, Practices & Plans

A game is a miniature environment, which can be evaluated based on some criteria, and redesigned to remedy ways in which it falls short. Tic-tac-toe is a very simple game that most adults do not find very interesting. This activity challenges participants to be explicit about how they would like the experience of play to improve, and then redesign the game to meet these criteria. The first problem is the establishment of clear criteria: Should the game be harder to win, be less predictable, take longer, require more complex strategy, or some combination of these? Next, participants have to determine how they want to change the rules to accomplish this goal. They may decide

the expand the playing board from 3 x 3 to 4 x 4, decide that only vertical and horizontal lines qualify for winning, include more than two players, invoke gravity (as in Connect Four), and/or allow each player two moves at a time. Any of these changes will have a major impact on the experience of playing the game. Finally, there is the issue of determining how well the redesigned game has actually satisfies the design goal. Challenge participants to be very specific about their goals, and about the evidence that would show how well these goals were met.

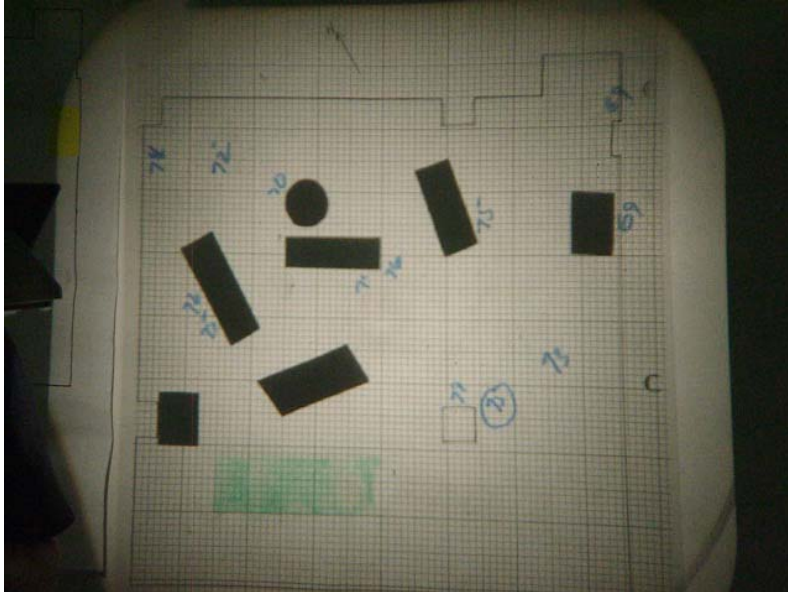

Mapping

The group will probably begin by inventing some sort of grid system. This system may be like giving directions in terms of city blocks, e.g., “six squares over and three squares up,” or more like the grid system on a road map, such as “F3.” They may not notice initially that each side has turned the board around so that their pieces are closest to them. This is an orientation problem that they will need to deal with either by turning the board around, or modifying the grid system to have different starting points and opposite directions. Another issue is how to communicate both the starting point and end point of a move in the game: should this be done using absolute positions (e.g., “from F3 to E4”) or directions relative to the starting point (e.g., “from F3 one square forward and to the left”). Emphasize that the object of this activity has nothing to do with winning the game. The design task is to come up with a way of describing locations on a checker board that you can’t physically see.



Packaging & Other Structures

In this activity, participants need to look carefully at an existing design, and use it as a basis for redesign. Encourage participants to look carefully at the various styles of folding boxes before deciding which one to use as the basis for their own design. Sometimes, they will simply reproduce the existing design, without changing its dimensions. Suggest that they redesign their box so the object fits more snugly. This will require them to examine how the dimensions of the various sides will correspond to the dimensions of the box when folded up. They will also need to be attentive to the various tabs and slots that enable the box to stay together without tape or glue. Encourage participants to explore how different materials compare in their ability to both fold and also hold their shapes. Materials can include cardboard, butcher paper and construction paper.

Sharing & Discussion

Because each of the groups is engaged in a different task, their report will need to include a summary of their task, as well as how they accomplished it and what they learned. Encourage them to be as specific as possible about the process they went through, including not only successes, but also bad ideas, false starts, dead ends, and redesign challenges. These illustrate design processes far better than some neatly packaged “finished product.”

Encourage the groups to reflect on their process in other ways as well. How well did their group function, and what did they learn about themselves and their group members? What did they learn about design? What thoughts do they have about how this sort of activity could contribute to elementary education?

If the room is crowded, and an overhead projector is available, you may want to have the groups create transparencies and make presentations from the front of the room.

Otherwise, it is easier and less formal to conduct a science-fair style walk around to each table, using the objects themselves as visual aids.



Designed Environments: Places, Practices & Plans

Summary of Key Concepts

People design things all the time, but most design activity is not particularly systematic. Usually, there is only a vague notion of what the design is supposed to accomplish; few if any alternatives are considered; and there is little if any effort to test the design. As a result, there is an accidental, unplanned quality to many of the environments we live and work in. These include not only the organization of space, but also the procedures that govern activity, and the plans and schedules that regulate the use of time. Most of this environment is the product of “everyday” or “casual” design, made with little or no analysis and evaluation. By contrast, we advocate for what we call “technological design,” which requires an explicit statement of the problem, examination of alternatives, and evaluation of the design to see how well it meets the original objectives.



Designed Environments differs from the other ***Stuff that Works!*** topics in that there is little if any predetermined knowledge base. The background information needed to carry out a design project is particular to the problem at hand. For example, a project to increase display space for children’s work draws on different kinds of knowledge from a project to reformulate the rules governing children’s access to the bathroom. The common feature guiding Designed Environments projects is that each one draws on and develops systematic design methods. The following are important elements of design:

- **Identify the problems:** Technological design activity arises from the sense that our lives could be improved by changing an existing product, procedure, or plan, or by creating new ones. The vague feeling that something needs to be changed is

only a first step in a design process. The more information you have, the better you can define the problems. For example, most people are not very satisfied with the ways their desks (or other workspaces) are organized. However, redesign of a workspace requires an explicit statement of the problem to be solved. You might realize that your desk has a large pile of items that get in the way of any work you need to do. “My desk is cluttered” is not nearly as useful a problem statement as “I need a place to put each of these types of things.”

- ❑ **Gather and analyze information about the problems:** One way to approach a problem is to analyze it thoroughly into its component parts; for example, by sorting the kinds of items found in the desk clutter. Another useful type of information describes the ways others have dealt with similar problems. For example, in addressing desk clutter, it might be helpful to look at other people’s desks, or study an office supply catalog showing various types of “desk organizers.”
- ❑ **Establish criteria for a redesign to meet, determine constraints that must be observed, and identify resources that are available:** Unlike everyday design, technological design takes clear account of criteria and constraints. Setting criteria for a design means being explicit about what a design is supposed to accomplish. Constraints are limits on the design choices. In the case of a desk redesign, criteria might include easy access to a telephone, a keyboard, a pencil sharpener or a stapler; adequate space for filling out forms; or ability to find important documents within a reasonable amount of time. Constraints could include a budget for office supplies, the total available amount of desktop area, or the need to share it with others. Resources include the knowledge a desk user has about what does and doesn’t work, total amount of space, available drawers and shelves for storing things, etc.
- ❑ **Formulate possible solutions:** There are a variety of solutions to any design problem. These alternatives usually differ in how well they meet the criteria and respect the constraints. Casual or everyday design typically selects one solution without examining how other possibilities compare. Technological design calls for specifying several possible alternatives, and then considering how well each one addresses the criteria and the constraints. For example, possible solutions to desktop clutter might include throwing away everything on top of the desk, clearing out some files to make room for the stuff on top, buying additional storage space, or making cabinets or shelves from recycled cardboard.
- ❑ **Select the best solution:** Given different possible solutions, how do you choose the “best” one? The selection is based on a prediction of how well each possible solution would respond to the design criteria and constraints. Often, the best choice combines useful ideas from a variety of proposed designs.
- ❑ **Implement the chosen solution:** The realization of any design is itself a design problem. Sometimes implementation is relatively easy, as in making changes in

one's own desk. It takes much more planning to institute a new design in a large, shared space such as a classroom or a cafeteria.

- ❑ **Evaluate the new design:** Evaluation is the most difficult part of a design project. There is a strong tendency to stop with the new design, regarding it as the end point of the process. But the question then remains: *Is the new situation better or worse than the old one, and in what ways?* Design criteria inform the evaluation, by telling what the new design is supposed to accomplish. Perhaps the new design simply doesn't meet the criteria, and the prediction that it would was wrong; or maybe other alternatives would have worked better. Sometimes a design meets the explicit criteria, but is clearly inferior to the former situation. The criteria should then be modified. In any of these cases, there is an obvious need for going through some or all of the process again; i.e., a need for *redesign*.

Preparation of Workshop Space

Arrange the furniture of the workshop space in an *inappropriate* way. It should not be so bad that workshop activities are impossible, but bad enough that it is difficult to conduct some of the workshop activities. One of the workshop activities will be to identify some of the issues raised by this bad design, and to correct these problems by redesigning the space.

For the redesign activity, you will need outline maps of the room, drawn to scale, one per group, and measurements of the major pieces of furniture, reduced to the scale of the map. These maps may be done on 8 1/2 x 11" graph paper, and then duplicated onto transparency films or plain white paper using a photocopier. Otherwise, they could be done on large sheets of chart paper, but you will need to create one of these maps for each group. This is the same kind of outline map used in the Mapping workshop; and the furniture will be represented the same way as in the concluding activity "Scale Maps." Therefore, it is useful to precede the Designed Environments workshop with the Mapping workshop, if at all possible.

After making the maps, survey the tables in the room that are movable, to find out how many different sizes exist. Then measure one of each size, record the length and width, and convert these to the scale of the outline map. Later, you will provide these measurements to the participants, so they can make scale cutouts and attach them temporarily to the outline map.

Workshop Materials

- ❑ Scale map of the workshop space, on chart paper and/or transparency film (see above)
- ❑ Chart paper

- ❑ Markers
- ❑ Rulers
- ❑ A Connect Four game set
- ❑ Large collection of counters, checkers, or coins, in at least two colors or sizes, for playing Connect Four. Alternatively, you can make playing pieces by cutting squares of cardboard approximately $(3/4)$ " x $(3/4)$ " in two colors.
- ❑ Approximately 11" x 14" sheets of graph paper with 1" x 1" grid squares, for making Connect Four. These can be cut out from a larger pad, or made with a ruler on a sheet of legal-size paper and then photocopied.
- ❑ Copies of Room Redesign Worksheet and Game Redesign Worksheet (see next two pages)

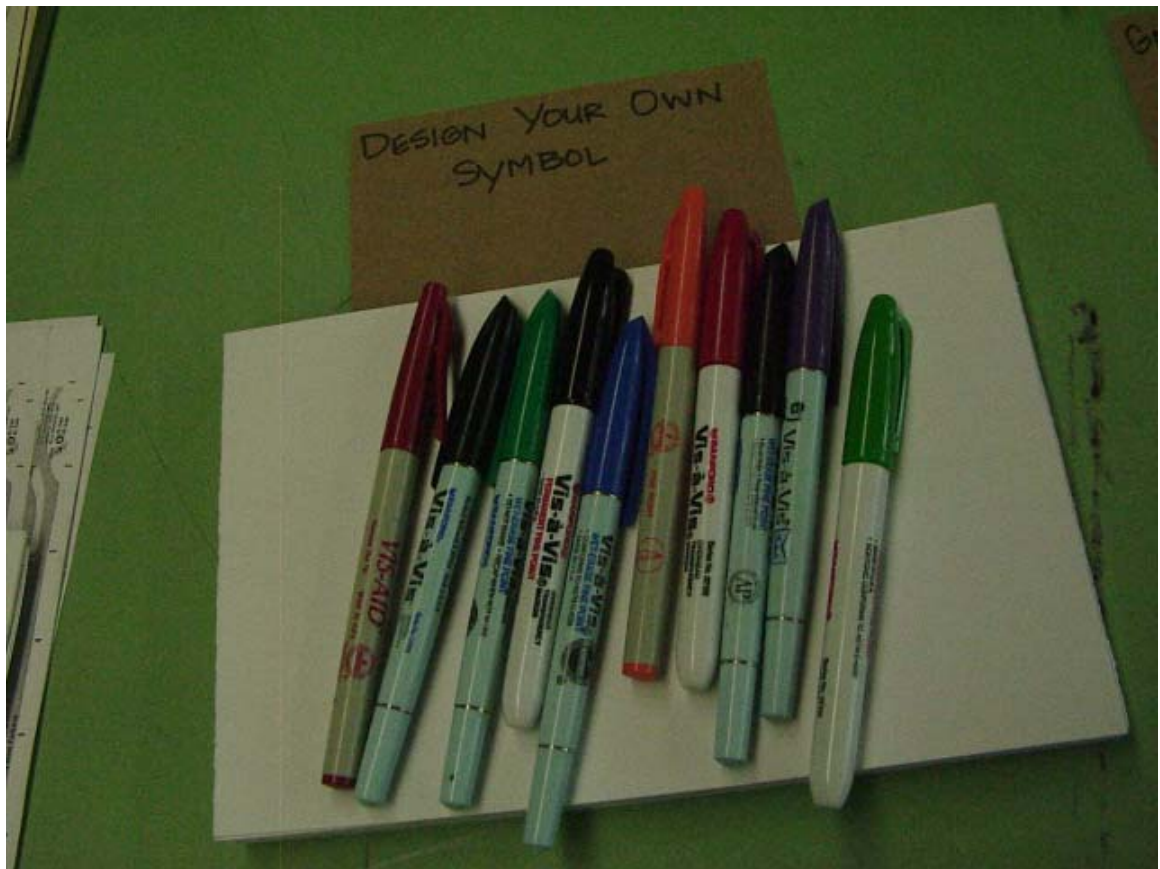

Room Redesign Worksheet

Original Design	
Problems with this design:	Criteria for a better design:
Resources available for redesign:	
Constraints that limit design options:	
Evidence that you could use to evaluate a new design:	
After Redesign	
Evaluation of how well new design worked:	
Criteria that were missed in evaluating the design:	
Changes that you might make for next redesign:	

Game Redesign Worksheet

Design Goal (Describe what you wanted the experience of playing the game to be like):	
Rules and Game board (Describe how you redesigned the game each time to accomplish your design goal; include a sketch or description of the game board)	Observations & Outcomes (Describe how well each redesigned version worked to meet your goals)

Directions to Participants

The following five pages provide a set of instructions for the workshop activities, suitable for copying to transparency films, PowerPoint slides, or chart paper, for use during the workshop.

DESIGNED ENVIRONMENTS

1. What's Wrong with this Room?

Use the Room Redesign Worksheet to list:

- The PROBLEMS with the current arrangement of furniture
- The CRITERIA a good classroom design should meet
- The RESOURCES available for redesign
- The CONSTRAINTS that would limit a new design
- Some EVIDENCE that a new design would be better than the current design

DESIGNED ENVIRONMENTS

2. Making it Better

- Design an arrangement of furniture that will:
 - Address the current problems.
 - Meet the criteria for a good design.
 - Work within the resources and constraints.
- Map your design on a transparency or chart paper.
- Develop a composite design that incorporates the best features of all the designs presented.
- Decide how to implement the new design.
- Rearrange the room.

DESIGNED ENVIRONMENTS

3. The Game Plan

- Learn the game of CONNECT FOUR.
- Divide into pairs. Each pair should then use a 6" x 7" piece of grid paper to play CONNECT FOUR.
- Decide on a criterion for redesign of the game. Develop a set of rules that you think will meet your criterion.
- Provide the rules to another pair of players, and watch as they play. Determine the effect of the new rules on their experience of playing.
- Redesign the game, as needed to meet your criterion. Use the Game Redesign Worksheet to keep track of each design cycle and its effects.

DESIGNED ENVIRONMENTS

4. Classroom Design Challenges

- Describe occasions when students identified classroom problems, and/or suggested ways of handling them.
- Make a list of things that get in the way of teaching and learning in your classroom.
- Identify items on your list that could be addressed by children; e.g., room arrangement, procedures, rules, methods of organization.
- For one item in number 2, list criteria that would tell you a new design was working better than the old.

DESIGNED ENVIRONMENTS

5. How Did We Do?

Use the Room Redesign Worksheet to list:

- Your **EVALUATION** of the redesign of the room: How well did the redesign of the room meet each of our criteria?
- Any **CRITERIA** that should have been included in the original list, but were not
- Based on the evaluation, any additional **CHANGES** that should be made in the room

Sample Workshop Agenda

Introductions (10 minutes)

Brainstorm: What's Wrong with this Room? (20 minutes)

Introduce the idea that reorganizing a room appropriately is an example of a design problem. Reveal that you have set up the workshop space using a deliberately bad design. Lead a brainstorming session to elicit the problems with the current space. Then, make additional brainstorming lists of the criteria a good design would have to meet, the constraints that limit the design, and the resources available for design. Conclude with a list showing the kinds of evidence that would indicate that a new design was working better than the current one. Post all five lists (Problems, Criteria, Constraints, Resources, and Evidence) so they are visible to the participants. Alternatively, each group can be asked to come up with its own list, using the [Room Redesign Worksheet](#), and the information from all the lists can then be shared. This and the next activity are based on Activities #5 and #6 in [Designed Environments](#).

Redesign: Making it Better (45 minutes)

Based on the brainstorming results, ask each group to develop plans for the rearrangement of the workshop space. They should make an effort to address the problems that have been identified, and meet the criteria while observing the constraints. Provide each group with an outline map, either on chart paper or transparency film, and post the measurements of the various table sizes, converted to the scale of the map. Each group should then make paper cutouts representing the tables, and place these on their map, to model various furniture arrangements.



Once the designs are complete, ask each group to present their design, and to explain how and why they think it will meet the criteria. From among the ideas presented,

the whole group should develop a composite design they believe will work best. If there is no consensus, sort the issues into a small number of basic decisions, and ask them consider each of these design elements separately, and take a vote on each one. For example, the arrangement of the worktables, the location of the supply table, and the position of the workshop leader, might each be handled separately, if there is disagreement about these issues. Then discuss how to move the furniture efficiently, and actually rearrange the room using the composite design as a basis. This design will be evaluated at the end of the workshop.

Design: The Game Plan (60 minutes)

A game is a miniature environment with its own spaces, rules, and procedures. Games are easy to redesign because they are self-contained and relatively simple. This activity explores redesign processes within this very restricted environment. It is based on Activity #4 in Designed Environments.

1. Introduce the game of Connect Four and invite two volunteers to demonstrate how to play. Make sure everyone learns the rules: each player uses a different color; players alternate; four-in-a-row wins; the winning line can be horizontal, vertical, or diagonal.
2. Organize the participants into groups of two. Distribute the sheets of graph paper and the playing pieces in two colors. Each group rules off a 7" x 6" rectangle on their graph paper, to make the playing area have the same number of positions as the commercially available Connect Four game. They then spend a few minutes playing Connect Four using these materials instead of the pre-fabricated game set. Ask how this "homemade" version of the game is different from playing on the manufactured Connect Four frame.
3. Discuss how one could change the rules of Connect Four. By using the grid squares, they are free to change the size of the board, number and arrangement of squares needed to win, simulation of gravity, etc.
4. Ask them to make one change in the way the game is played, and then try playing the game a few times using the new rules, and see how this change affects the experience of playing the game. Was it easier, harder, more frustrating, more boring, or more fun? Did the game take more time, less time, involve more strategy or less?
5. Ask each group to identify one design criterion to be met by changes in Connect Four, and to design a version of the game with this basis in mind. When they are satisfied that the new design meets this criterion, they should then write down the rules for this new version of the game.
6. Each group is to provide its new set of rules to another group, which then plays the modified game. As they do, the designers should find out whether the new rules had the intended effect. Then they should redesign the game and try again, keeping track of all changes and their effects on the Game Redesign Worksheet.

Brainstorm: Classroom Design Challenges (30 minutes)

Lead a very brief discussion about how children have identified and/or helped in solving problems in the classroom. For example, children may have suggested new procedures for lining up, sharpening pencils or organizing lunch, new methods for handling interruptions, or new ways of using classroom space. Ask the teachers to describe examples of their own. This discussion will lay the groundwork for the following brainstorming session.

Next, ask each group to make a brainstorming list of things that get in the way of teaching and learning in the classroom. Then, they should mark items on this list that could be open to redesign by children. Many of the items on these lists will be well beyond the control of teachers, let alone children. However, there will very likely be some problems for which children really could design and implement solutions. Ask each group to identify such items from their list. These might include procedures for distributing lunch, handling of classroom interruptions, or redesign of the furniture arrangement.

Once these items have been identified, ask each group to select one item on their list to develop further. Let them imagine that they had involved students in redesigning that aspect of classroom life. What would they look for to demonstrate how well the new design was working, compared with the old arrangement? See Activities #1, #2 & #3 in Designed Environments

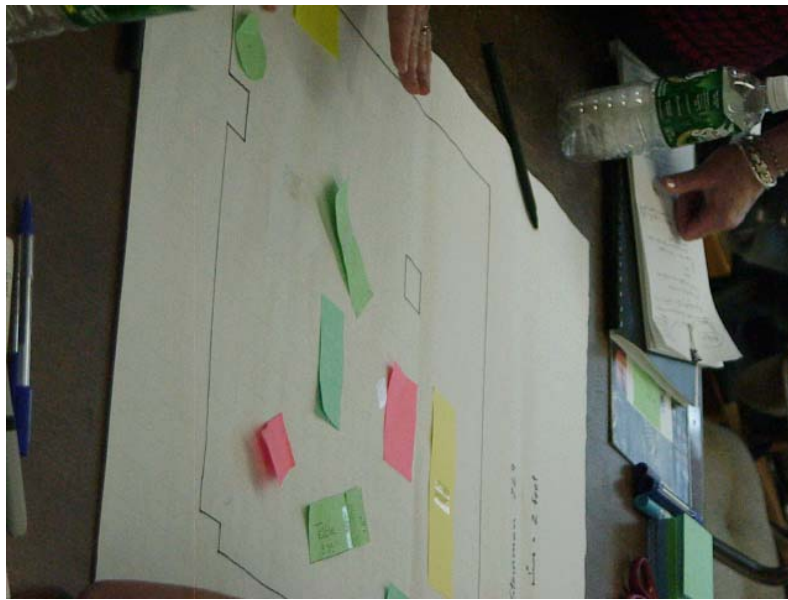

Evaluation: How did we do? (15 minutes)

Discuss how well the redesigned workshop space has been working. Does it promote small group activities? Is it conducive to whole-group brainstorming? Then post the original list of criteria that the redesign was supposed to achieve. Does the new design meet these criteria? What evidence is there to show its level of effectiveness? Are there

criteria that should have been on the list, but are not? What further changes should be made to improve the design of the room?

Reflecting on Classroom Possibilities (15 minutes)

Lead a whole-group discussion on how the teachers might plan and implement classroom design or redesign projects. These projects could address the organization of space, or on the redesign of rules or procedures. Focus on how a project could be initiated, and to what extent it would include the design stages outlined under “Summary of Key Concepts” (pp. 38-39).

Workshop Tips and Strategies

Preparation of Workshop Space

When you set up the room, include some obvious design flaws that could be mildly irritating to the participants, but which will provide obvious room for redesign. Don't go overboard; the space should still be somewhat usable. For example, you might put the tables too close together, making it difficult to circulate around the room. Alternatively, the tables could be distributed so widely that some are not visible from one another, making it hard to have whole-group discussions.

Brainstorm & Redesign of Workshop Space

This activity is an example of user involvement in design. You are turning over to the teachers a task usually reserved for workshop leaders: the arrangement of the workshop space. In a similar way, Designed Environments calls on teachers to relinquish some of their traditional control of the classroom environment, by involving students in the redesign of spaces and rules. Some teachers may resist this idea, so it is important to model the process, by demonstrating that you are willing to let them modify their own workshop space.

The new arrangement will not be perfect, but it will probably be an improvement over your deliberately bad design. Encourage the participants to see design as an ongoing process, where improvements are made incrementally, with each new design based on the flaws in the previous one. Some participants may object that there are still problems with the furniture arrangement, and may want to modify it again immediately. Point out that there is no such thing as a perfect design, and that every redesign should be based on data showing the deficiencies of the previous design. Suggest that by living with the design for a while, they could collect additional data. Thus, it is better to wait, than to do another redesign immediately.

Design: The Game Plan

Children (and adults) frequently make changes in sports and games to accommodate particular situations. There may not be enough players, not enough playing

space, or not enough time, so the rules and/or playing areas have to be modified. For example, baseball is often adapted to a small playing area by reducing the number of bases and/or restricting where the ball may be hit. Checkers can be speeded up by allowing kings to advance the length of the board in one move, like bishops in chess. Monopoly is another game that is often redesigned. If participants are unclear about what it means to redesign a game, solicit some examples like these.

Develop the idea that games are miniature environments, and that we can redesign them to meet our own needs. Then, in playing and redesigning Connect Four, help teachers understand how criteria are established to guide a new design, and how that design can be evaluated to see how well it meets the criteria. For example, a simple change in the number needed for victory will make the game go much faster or slower. “Connect Five” is much harder to win than Connect Four, and many games end in a draw. “Connect Three,” on the other hand, ends very quickly.

Brainstorming: Classroom Design Challenges

The first list of problems could include anything at all: behavioral issues, administrative decisions, state requirements, budget cuts, physical plant, etc. Many of these issues are clearly beyond the control of teachers and students. These might be identified as *constraints*. On the other hand, teachers (and students) could actually make changes in the arrangement of furniture, the storage and/or distribution of materials and supplies, procedures for handing in or returning homework, and perhaps even handling of interruptions. Typically, teachers, not children, undertake these design problems. Participants will need to see that children can and should become involved in much of the design work that teachers routinely do. To develop this idea, it is useful to elicit examples of suggestions that children have already made for improving the classroom environment. Then they can look at their own lists of classroom problems to find opportunities for involving children in solving them.

The goal of these brainstorming activities is for participants to become aware of possible redesign activities in their own classrooms. Some important outcomes are the understanding that children can think creatively about their classroom environment, and that these projects can help students develop design skills and a sense of responsibility. List some of the more promising ideas on chart paper so teachers can refer to them during the concluding discussion on “Classroom Possibilities.” See Chapter 2 of Designed Environments for a wide variety of possible projects.

Evaluation of Workshop Space Redesign

The workshop space design should first be measured against the original design criteria. Often, it will turn out that the original criteria may have been met, but there were additional criteria that were never considered. These may actually be more important than the criteria that were met! When this occurs, use the example to point out that real design processes may fail to conform to an idealized design cycle. Design is messy, and testing a design often reveals that the problems were not understood well at the outset. Furthermore, design is an ongoing process, and that the first attempt at design rarely

provides a completely satisfactory solution. By evaluating a design, you uncover weaknesses that should serve as the basis for the next iteration.

Reflecting on Classroom Possibilities

The purpose of this final reflection is to make it more likely that teachers will engage children in a Designed Environments project. Be open to the teachers' misgivings and the problems they foresee, for many teachers find it difficult to "relinquish control." Emphasize that students' design ideas will still be subject to teacher review, and will affect the classroom environment in controlled ways. Then help them see possible starting points in their own classrooms, and the benefits for their students. Often design issues arise spontaneously, based on a suggestion by a student, or a problem that makes itself obvious. Participants should become able to recognize these as opportunities for Designed Environments projects.

Mapping

Summary of Key Concepts

The word “map” sometimes has a very broad meaning. We talk of “concept maps,” mental maps,” and “mapping out my day.” In the Mapping guide, however, we focus mainly on maps that are used to communicate about physical space. This narrower type of map is called a **spatial** or **geographical map**. Such a map might show friends how to get to one’s home, or how the rooms are laid out. These maps reveal different ways to get to a destination, the towns a road passes through, and the distances between the towns. Other spatial maps tell of topography, the weather across the country, or the incidence of a disease, all as functions of location. The focus of Mapping is upon maps as tools of communication. The basic idea is that maps represent places and the locations of things.



Spatial maps are meant to communicate what is in a space, and where each thing is. The map-reader expects a **correspondence** between what is shown on the map, and what is seen in that part of the real world represented by the map. If the neighborhood map shows a school and two candy shops, we expect to find a school and two candy shops when we visit the neighborhood. There should also be a correspondence between the relative positions of things shown in the map and the positions of those things in the real world. If the map shows one candy store across from the school and the other a block to the east, then that is where we should find them on the actual street.

Correspondence in mapping is somewhat of a one-way street. We expect the things shown in a map to be present in the real world. However, we don’t expect everything in the real world to be present in the map. Potholes are an unpleasant part of a driver’s trip, but we don’t expect them to be shown on a map – unless of course we are members of the road crew sent to repair the potholes. Maps only show the things that the

mapmaker wants to emphasize; i.e., that are part of the information that the designer of the map wants to communicate.

In order to depict real-world things the mapmaker uses **symbols**. The symbols may range from a drawing of the thing, to an icon, to something as abstract as a geometrical form. (Because of the role of symbols in mapping, some professional developers have chosen to conduct the workshop on Signs, Symbols & Codes prior to Mapping.) In the initial maps of their rooms, children usually draw pictures of the bed, dresser, desk, television, and so forth. Later they develop more abstract ways to represent these things. As the symbol system becomes more abstract, the need for a legend or key becomes more apparent. The **key** connects each symbol with its meaning.

Maps are drawn from one or more **points of view** or **perspectives**. In their earliest maps, children may use multiple points of view. In children's first maps of their bedrooms the bed is frequently drawn from the top, or bird's eye view, while the dresser and walls are drawn from a side view. As they gain experience, children become more consistent in their use of perspective.

When using a map to find the way to a destination, the map must be **oriented** to the space it represents. There are two main ways to orient a map to a space. If the direction of North is known and the map shows North by an arrow or compass rose, then turn the map so the arrow indicating North points in the northward direction in real space. To use the second method of orientation, identify where you are on the map. Then align the map so that the direction from your location to a landmark on the map is the same as the direction from you to the same landmark in the real world. A landmark could be anything shown on the map, and also observable from where you are.

Most published maps are drawn to a **scale**. This means that a particular distance on a map represents a specified distance in the world; for example, one inch stands for one mile. Thus if it is one mile from 100th Street to 120th Street, then the map is drawn so that the map distance from 100th Street to 120th Street is one inch. The scale expresses the fixed **ratio** or **proportion** between map distance and real distance. By appropriate choice of scale, a map-maker can fit a whole country, a state, a city, a building, a classroom, or a desk top on an 8 ½" x 11" piece of paper. If the scale is reasonable, the map can be made to fill most of the available paper.

The set of lines on graph paper is called a **grid**. A grid is useful in making a map to scale. Initial classroom maps may use a scale in which one grid square represents one floor tile. The grid can also provide a way of finding specific locations on a map. Letters and numbers can identify the horizontal and vertical rows and columns, respectively. Then, each square on the map is assigned a letter and a number, based on the row and column that intersect there; e.g., the intersection of row G and column 8 would be called G8. In math, this method of identifying a location in space is called a **coordinate system**.

Pre-workshop Scavenger Hunt

Ask participants bring any interesting maps with them to the workshop.

Workshop Preparation

Prior to the start of the workshop, you will need to make an outline map of the workshop space on a large sheet of gridded chart paper. To make this map, measure the length and width of the room using a convenient unit, such as floor or ceiling tiles, wall panels, light fixtures, or windowpanes. Then determine an appropriate scale, relating grid squares to measurement units that will allow you to fit the entire map on the page. Use a scale other than one-to-one, so that participants can see how the scale of a map is related to ratio-and-proportion. For example, one grid square on the chart paper might represent a square of four floor tiles (two-by-two); or two-by-four grid squares might be equivalent to one large rectangular ceiling panel, etc.

Workshop Materials

- ❑ 8 ½” x 11” graph paper for map making
- ❑ Chart paper and markers
- ❑ Rulers and tape measures
- ❑ Large Post-its, colored index cards or construction paper
- ❑ Masking tape
- ❑ A diverse collection of spatial maps, including road maps, topographical maps, weather maps, political maps, floor plans, building maps, bus line maps, maps of parks, zoos, and so forth
- ❑ A few things that might be considered “maps,” but that do not represent physical space: e.g., tables, graphs, flow charts, concept maps, time lines, and block diagrams
- ❑ A collection of discarded magazines and newspapers
- ❑ Overhead transparency films and markers (if projector will be available)
- ❑ Copies of Map Analysis Worksheet and Mystery Table Map Worksheet (see next two pages)

Map Analysis Worksheet

Looking at Maps of Physical Space	
Title of Map	List of features found on the map
List the features NEEDED for a map of physical space:	

Mystery Table Map Worksheet

Original Design	
Map features	Observations and Outcomes
List the features you included on your map.	Describe the difficulties the testers had in using your map.
After Redesign	
Map features	Observations and Outcomes
List the features you added each time you redesigned it	Describe the remaining difficulties the testers had in using your map.

Directions to Participants

The following six pages provide a set of instructions for the workshop activities, suitable for copying to transparency films, PowerPoint slides, or chart paper, for use during the workshop.

MAPPING

1. Scavenger Hunt

- Search newspapers and magazines for anything you might consider a map.
- Cut each one out and save it in a pile.

MAPPING

2. Guess my Categories!

- Sort the maps from the scavenger hunt, plus maps supplied by us, according to your own SECRET CATEGORIES.
- Place your groups of maps on the table so others can try to guess the basis for each category.

MAPPING

3. Looking at Maps of Physical Space

Examine a variety of maps of physical space. Determine the features that each map uses to represent some aspect of physical space. Use the Map Analysis Worksheet to list:

- The features you found on EACH map
- The features that SHOULD BE included on any map of physical space

MAPPING

4. Mystery Table Arrangement

- Place a circular object, a long straight object and a rectangular object randomly on the table.
- Make a map, showing their locations accurately.
- Remove the 3 objects to one side.
- Challenge another group to restore the original arrangement, using only the map as a guide. NO COACHING!
- Based on the problems the other group encounters, redesign your map to make it easier to follow. Then let the other group try again.

Record all data on the Mystery Table Map Worksheet.

MAPPING

5. Map this Room

- Each person, make a quick, rough map of this room and post it on the wall.
- Compare your map and others' maps. Look for similarities and differences.
- Which maps are easy to read?
- Which are more difficult?
- What map elements make the maps easier to understand?

MAPPING

6. Scale Maps

- Make a paper cut-out of your table to the same scale as the master map of the room.
- Place the map of your table in the proper place on the master map.

Sample Workshop Agenda

Introductions (10 minutes)

Scavenger Hunt (10 minutes)

Ask the teachers to search through the old newspapers and magazines for anything they might consider a map. See Activity #7 in [Mapping](#).

Sorting: Guess my Categories! (30 minutes)

Combine the maps you have assembled with those brought in by teachers, and those cut from magazines and newspapers. Include such items as concept maps, flow charts, time lines, block diagrams, and other graphic devices for organizing information. Provide each group with a diverse collection of maps, and ask them to sort them according to their own secret categories. The other groups will then have to guess the categories.

Analysis: Looking at Maps of Physical Space (20 minutes)

Provide each teacher with a variety of maps that represent some form of physical space. This has probably been one of the categories used in the sorting activity. What features does each map use to convey information about physical space. What characteristics do they have in common? How do they differ? Then ask the groups to decide what features a map of a physical space should have. The [Map Analysis Worksheet](#) will make it easier to organize the information. Activities #2, #8 and #9 are relevant here.

Design I: Mystery Table Arrangement (40 minutes)

Ask each group of teachers to select three small objects: one circular, one rectangular, and one linear. Examples are a roll of tape or a CD, a small box or index card, and a pen or pencil. They should place these objects randomly on their table, and then make a map showing the locations of the three objects. Next, they remove the objects to the side, and ask members of another group to place the objects in their original locations, using only the map as a guide. Emphasize that the purpose of the test is to evaluate the map, not the map-reading ability of the testers. The designers of the map should not provide any hints or coaching, as their map is being tested. They should note carefully the kinds of ambiguity or errors that result from attempts to use their map, and then use this information to redesign it. Then they should try it out again, keeping a record of the changes they made, and how effective they were. The [Mystery Table Map Worksheet](#) should be used to record all data. See Activity #14.

Design 2: Map this Room (30 minutes)

For a first experience in map-making, have each teacher individually draw the room they are in, as in Activity #11. This map should be done quickly on any sheet of 8

½” x 11” paper, not to scale, and then posted on the wall. Then conduct a “Gallery Walk,” where each participant examines all of the maps. Ask the teachers to compare one another’s maps for similarities and differences in how the room is portrayed. Encourage them to explore items that were included or excluded in their maps, and also to look for generic features of maps, such as point-of-view, correspondences between the map and the space that was mapped, use of symbols and a key, orientation, scale, and coordinate system (see “Key Concepts”).



Design 3: Scale Maps (40 minutes)

Display a blank piece of large grid paper and ask the teachers to figure out what scale should be used to represent the entire workshop room on this piece of paper. You may provide them with the measurements of the room, or have them measure it, depending on the time available. Discuss how well their suggestions would work: Would the entire room fit on the map? Would the map use up most of the available paper? See Activities #18 & #19.

Now display the outline map you have already made of the room (see “Workshop Preparation”), and explain the scale you used. Their task is to add their own tables to your “Master Map.” If there are other large furnishings besides the worktables, you may want to subdivide the groups, and assign other furniture items to some of the subgroups. Each group will need to measure at least one piece of furniture, and represent it using the same scale you used. They can cut these furniture “pieces” out from Post-its, if these are available, or else make them out of construction paper or colored index cards. Once a group has created its furniture cutout, ask them to determine the appropriate place to put it on the Master Map. To do so, they will have to take measurements of where the furniture is in relation to some landmarks, such as walls or columns. These measurements, too, will need to be scaled down. They should then attach their individual furniture pieces at the correct locations on the master map. Discuss how such a map could be useful, for example, in redesigning the furniture arrangement.

Sharing (15 minutes)

Lead the teachers in a discussion of the specific challenges of creating a scale map. Help them understand the process in relation to the math topic of “ratio-and-proportion.”

Reflecting on classroom possibilities (15 minutes)

The sample workshop agenda begins with activities accessible to all students. The last activities involving scale are generally too difficult below about fifth grade. Lead teachers in a discussion of how they might use these activities in their own classes.

Workshop Tips and Strategies

Workshop Preparation

As you assemble your maps, cast your net as widely as possible. Include not only maps of physical space, but also some more generic maps, which represent concepts, schedules, organizational relationships, or sequences of action. In the first two activities, teachers will make distinctions between maps of physical space, and maps in this broader sense. Also, be on the lookout for maps that are not very clear, such as posted maps that are oriented incorrectly, or maps that are lacking a key.

Scavenger Hunt and Sorting

The aim of these activities is to assemble the broadest possible collection of things that may be maps, and of ideas about what “maps” might be. The “Analysis” activity focuses more narrowly on spatial maps.

When children brainstorm and do scavenger hunts, they may include such things as TV schedules, restaurant menus, and even comic strips as maps. These can generate a fruitful discussion on what a map is. Teachers may be much more constrained and include only conventional geographic or spatial maps. If this is the case, be prepared with examples of concept maps, flow charts, schedules, and menus. Introduce these items to stimulate a discussion on the various possible meanings of “map.”

Analysis

This activity narrows the focus from the broad concept of “map” to the more restricted meaning of a representation of physical space. Some common characteristics of spatial maps are:

1. There is a correspondence between things shown on the map and things found in physical space.

2. A map is selective in what it shows; i.e., not everything in the physical space is represented on the map.
3. A map is made for a purpose, and shows information that helps accomplish this goal.
4. Maps use symbols to represent things in the world.
5. There is usually a key, explaining the meaning of each symbol.
6. Most maps have scales that tell the relationship between distances on the map and distances between corresponding places in the world.
7. A map is often made on a grid that uses a coordinate system to make things easy to find.
8. There is some way to orient the map to the real world: a compass rose or landmarks are used to show which way the map should be held when using it.

Design 1: Mystery Table Arrangement

This activity complements the analysis of spatial maps by demonstrating the necessity for some of the features listed above. Therefore, it is important that participants see for themselves what happens when these ingredients are missing or unclear. Make it clear that their only means of communication with the map users will be via the map; they are not to say or do anything that aid in the interpretation of their map. It is likely that people will have trouble using these first maps. These difficulties are important, because they will suggest the additional features that need to be added. By failing to place the objects correctly, users will reveal the deficiencies in the map. In other words, let the participants discover the need for orienting landmarks, scale, and grid systems without being told to include them. They will then invent these components as they redesign their maps.

Design 2: Map this Room

The request to “draw this room” may be elicit the response: “I can’t draw!” Emphasize that the drawing of the room is not intended as art, but as an attempt to communicate information. In discussing the maps, highlight how the teachers have used point-of-view, symbols, and labels. Compare the kinds of things they have included or excluded on their maps, what kinds of information these items communicate, and to whom the information might be useful. Discuss how the use of scale, grid system, orientation marks, a consistent point of view, symbols, and a key would make a map more or less useful for various purposes. This activity is analogous to #11 in Mapping, in which children make first maps of their own rooms.

Design 3: Scale Maps

This activity develops a basic understanding of ratio-and-proportion in a real-life situation. However some teachers may exhibit math avoidance (see pp. 31-33 of this Guide). For this reason, it is important to scaffold the activity, so participants can enter it on a variety of levels. Begin with a discussion about how to establish an appropriate scale for the Master Map. Then, you may want to give a demonstration of how to map one table, for example, the one you are using, to the same scale. Later you might lead a discussion about how to place the map of your table in the right position on the map of the entire room.

Mechanisms & Other Systems

Summary of Key Concepts

Mechanisms are devices that convert one type of motion to another. To use a tube of lipstick or a glue stick, you have to turn a knob. When you do so, the lipstick or glue comes straight out the other end. Inside of each device, there is a mechanism that takes the motion you supply, the **input**, and transforms it into the motion you want, the **output**. The two motions are different. The input motion travels around in a circle and is at one end of the glue or lipstick case. The output motion travels in a straight line, and is at the other end. Some common characteristics of mechanisms are that they all have moving parts, and the input is distinct from the output.



Many mechanisms are designed to produce more force at the output than is required at the input. This is true of a pair of nail clippers. A small amount of force at the input manages to produce a much larger force at the output – enough to cut through a resistant big toe nail! However, this big gain in force does not come for free. You have to move the handle through a much bigger distance, compared with the tiny movement of the jaws. This is a characteristic of all mechanisms: the larger the force, the less the distance traveled, and vice versa.

All mechanisms depend on a few basic principles, and the most important of these is the **Principle of the Lever**. It is possible to lift a heavy object, like a desk, by putting the end of a long board under it. Near the desk end, rest the board on a solid support that allows it to rotate. Then a small amount of force on the other end of the board will be sufficient to lift the desk. The board itself is a **lever**, and the pivot it rests on is called a **fulcrum**. The point where you apply the force is called the **effort**, which is just another word for input. The effect of applying this force, lifting the desk, is called the **load**, which is also called the output.

Many books give the impression that the fulcrum of a lever is always somewhere in the middle, which is the case for a **first-class lever**, but there are two other arrangements that are equally possible. In these the fulcrum is at one end, and either the load or the effort is in the middle. A **second-class lever**, such as a garlic press or a wheelbarrow, has the *load* in the middle. In a **third-class lever**, like a pair of tweezers or a staple remover, the *effort* is in the middle.

By looking at the load and effort arms, it becomes clear that the mechanical advantage of a second-class lever is always more than one, but for a third-class lever it is always less than one. Third-class levers are used to increase the *distance* traveled by the load, relative to the effort, rather than the *force*. The most familiar example is the human forearm. Some mechanisms include more than one lever, and use one lever to operate another. These are called **compound levers** or **linkages**. Examples include the nail clippers, vise grips, adjustable desk lamp, pedal-operated wastebasket, and umbrella. Because they have multiple parts working together, they are all examples of **systems**. A good way to understand a system is to make a **model** of it. A model has some essential features of the original, but omits others. For example, a cardboard model of a scissors might move like a real scissors, but be unable to cut.

The lever is often useful because the effort moves a lot more than the load, and therefore requires a lot less force. The amount of movement at each end is proportional to its distance from the fulcrum. The **load arm** and the **effort arm** are the special names given to the distances from the fulcrum to the load and effort, respectively. Using these definitions, the **Law of the Lever** is simply:

$$\text{Load arm} \times \text{load force} = \text{effort arm} \times \text{effort force}$$

Force times distance is energy, so this law says that the energy input equals the energy output; in other words, the energy doesn't change between the input and output. It is an example of the Law of Conservation of Energy. Using a little algebra, the Law of the Lever is equivalent to:

$$\frac{\text{load force}}{\text{effort force}} = \frac{\text{effort arm}}{\text{load arm}}$$

In other words, the lifting force is bigger than the effort in the same proportion as the effort arm is longer than the load arm. This ratio is so important that it is given a special name: **mechanical advantage**. A pair of nail clippers has a large mechanical advantage, because the end of its handle is so far from the fulcrum.

Science books usually identify six **simple machines**: the lever, wheel-and-axle, pulley, inclined plane, wedge and screw. Two of these – the wheel-and-axle and the pulley – are really examples of the lever. A **wheel-and-axle**, used to drive a car, is a third-class lever, because the outside of the axle, which supplies the effort, is in between the fulcrum and the load. A **pulley**, used to lift a weight, is a first-class lever, in which the fulcrum is at the center of the pulley, in between the effort and the load. Two of the other three simple machines– the wedge and the screw – are examples of the third – the

inclined plane. A **wedge** is a double-sided inclined plane, while a **screw** is an inclined plane wound around a cylinder or cone. The lever and the inclined plane are really the basis for all mechanisms.

Pre-Workshop Scavenger Hunt

Ask participants bring in any mechanisms they consider interesting or unusual.

Workshop Materials

- ❑ Collection of mechanisms, including first- second-and third-class levers, as well as compound types. First-class levers include scissors, pliers, and hole punchers. Common second-class levers are nutcrackers, garlic presses, and crank handles. Examples of third-class levers are tweezers, salad tongs and staple removers. Compound levers include vise grips, nail clippers, teabag strainers, and tin snips. See photo in Materials List for [Introductory Workshop](#).
- ❑ Thin squares (about 10" x 10") and strips (about 2" x 10"), cut from shirt cardboard, pizza boxes, file folders, priority or overnight express mail envelopes, or other cardboard of comparable thickness
- ❑ Rubber bands, scissors and hole punchers
- ❑ Overhead transparencies and markers (if projector is available)
- ❑ Mystery mechanisms: see the [Mystery Mechanisms Construction Guide](#) (next page) for instructions on how to make these from cardboard and paper fasteners. Tape a piece of cardboard or a file folder over both front and back of each mechanism, so only the input and output are visible.
- ❑ Copies of [Lever Class Worksheet](#), [Compound Lever Worksheet](#) and [Lever Representation Worksheet](#) (three pages following [Mystery Mechanisms Construction Guide](#) on the next page)



Mystery Mechanisms Construction Guide

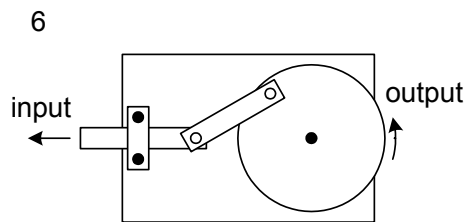
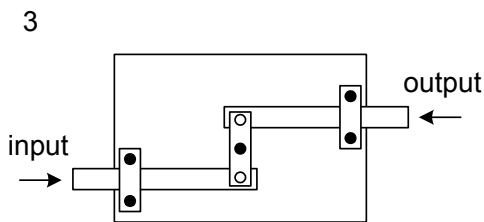
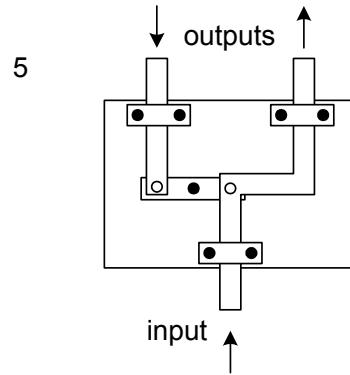
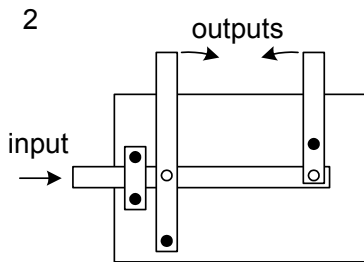
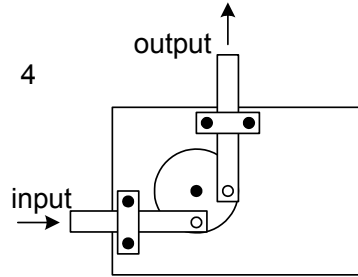
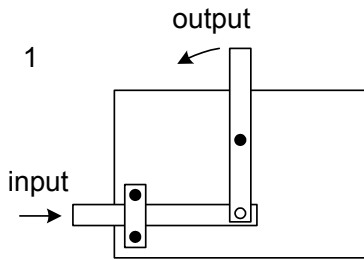

Key

- Fixed pivot (attaches link to base)
- Floating pivot (attaches link to link)
- ▭ ● ● Guide (maintains straight-line motion)

Lever Class Worksheet

List the levers you found from each class:

1st Class

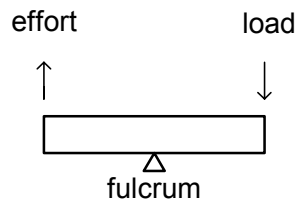

2nd Class

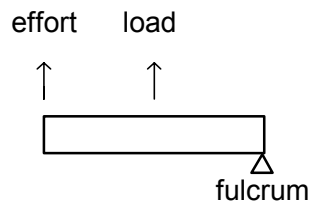

3rd Class

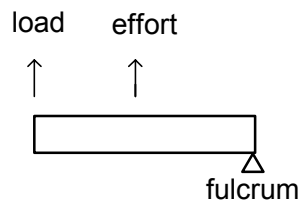

Not sure

?

Compound Lever Worksheet

1. Identify each lever, and draw an outline around it. Use a different color for each one. Then find the effort, fulcrum and load of each lever, and determine its class.

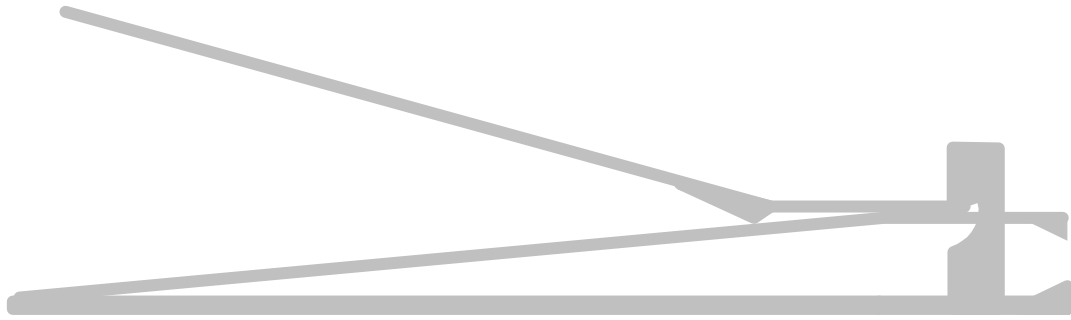

2. Draw another compound lever, and repeat #1

Lever Representation Worksheet

How could you represent your sorting of levers according to class, including compound levers that have more than one class? Sketch your method below, showing a few of the levers you've classified:

Directions to Participants

The following five pages provide a set of instructions for the workshop activities, suitable for copying to transparency films, PowerPoint slides, or chart paper, for use during the workshop.

MECHANISMS & OTHER SYSTEMS

1. Scavenger Hunt & Brainstorming

- Look at the mechanisms on your table. Add any others you have brought with you.
- Examine these devices carefully. Make a list of the features they have in common.

MECHANISMS & OTHER SYSTEMS

2. Guess my Categories!

- Examine your devices. Decide on a few categories for classifying them.
- Sort your devices into piles according to your categories. **DO NOT REVEAL THE CATEGORIES TO ANYONE OUTSIDE YOUR GROUP.**
- The others will have to guess your “SECRET CATEGORIES”!

MECHANISMS & OTHER SYSTEMS

3. Levers have a lot of Class

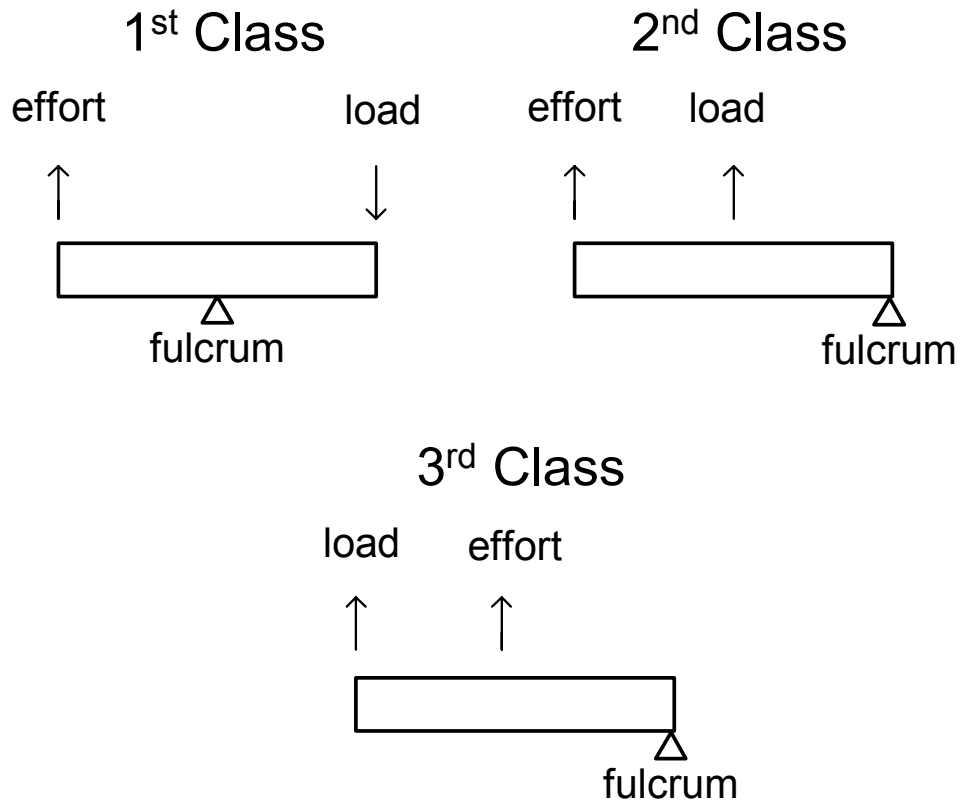

Sort your mechanisms according to 1st, 2nd and 3rd class levers. Use the Lever Class Worksheet to list the devices in each class.

MECHANISMS & OTHER SYSTEMS

4. Compound Levers

- Examine the nail clippers closely. Use the Compound Lever Worksheet to identify the levers it includes, and show the fulcrum, effort and load of each lever. What is the CLASS of each lever?
- Select another compound lever. On the worksheet, draw the device. Show each lever in a different color, and identify the fulcrum, effort and load of each one.
- Design a method to include compound levers of more than one class in your lever sorting scheme. Use the Lever Representation Worksheet to show your method.

MECHANISMS & OTHER SYSTEMS

5. Mystery Mechanisms

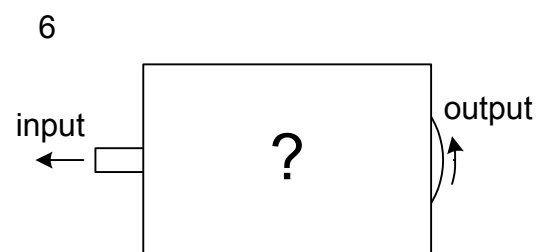
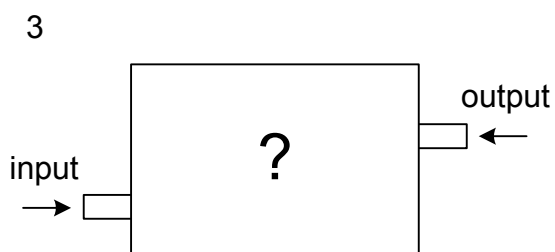
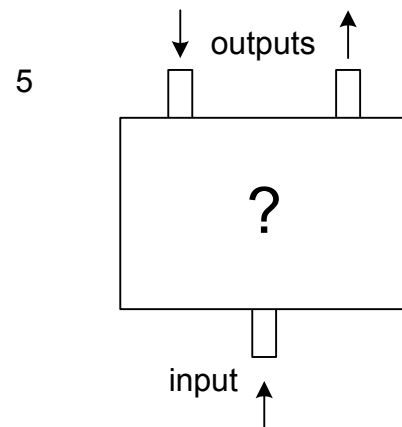
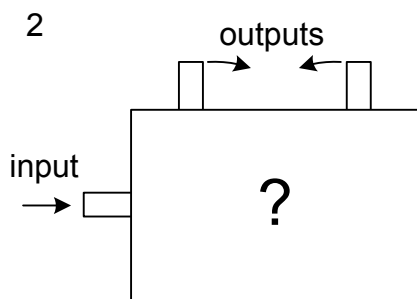
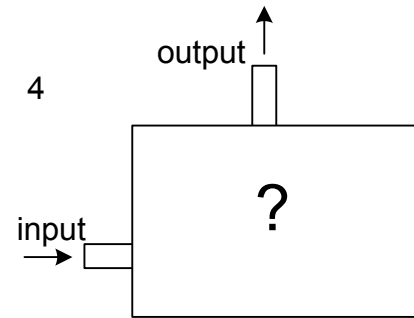
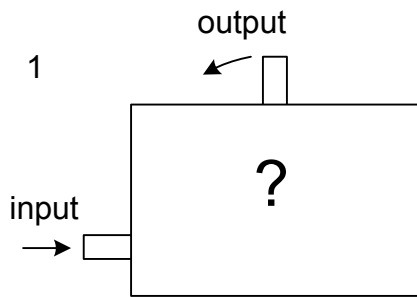

Sample Workshop Agenda

Introductions (10 minutes)

Scavenger Hunt & Brainstorming (20 minutes)

Provide each group with a few mechanisms, and ask the participants to find as many more as they can, either in the room, or from among their personal effects. Then ask them to look carefully at these devices, and determine the characteristics they share in common. See Activities #1 & #2 in Mechanisms.



Sorting: Guess my Categories! (30 minutes)

Collect all of the sample mechanisms, including those found during the scavenger hunt, and any that were brought in from the pre-workshop activity. Include the linkages and compound levers (see “Workshop Materials”). For any mechanism that can’t be removed, such as a doorknob, window latch or pencil sharpener, they can write the name of the mechanism on an index card. Provide each group with at least half a dozen of these items. They are to sort their devices according to categories they determine, but do not reveal to the other groups. Once they have done this, another group should visit their table and try to determine the basis for their categories. After each group has revealed their categories, repeat this activity, encouraging each group to come up with different and more interesting categories. Activity #4 is the basis for this work.

Analysis 1: Levers have a lot of Class (20 minutes)

Describe the basic parts of a lever -- fulcrum, effort and load -- using as examples the mechanisms already examined. Then describe first-, second- and third-class levers. A reference chart, showing the three classes of lever, is included in “Directions to Participants”. Provide examples of each class from the collection of mechanisms, for example: a one-hole punch and a scissors (First Class); a nutcracker and a garlic press (Second Class); a staple remover and a pair of tweezers (Third Class). See also pp. 45-46 of Mechanisms.

Ask each group to sort their mechanisms according to lever class. Introduce the terms input, output, and range of motion. They will need to identify and perhaps draw the effort, fulcrum and load, and determine whether these are arranged as a first second or third class lever. The [Lever Class Worksheet](#) should be used to record the results.

Analysis 2: Compound Levers (40 minutes)

In the first Analysis activity, some devices should be included that have more than one lever. Rotary can openers fall into this category, because they each have two independent levers, the arm that punches the hole in the can and the handle that turns the little wheel. The more interesting devices are *compound levers*, in which the output of one lever is the input to the next. Examples include a pair of nail clippers, tin snips, teabag strainer or vise grip. It is not so easy to classify these. Participants will need to identify *each* lever, and determine its class separately. The [Compound Lever Worksheet](#) is a good place to start, because it already shows a drawing of a nail clipper, and asks them to identify each lever, the fulcrum, effort and load of each, and its class. It consists of a second-class lever (the handle) operating a third-class lever (the upper jaw). Another problem is how to represent the compound levers in the sorting lists of first-, second- and third-class levers. A device having both a second- and a third-class lever does not fit neatly in either category. The [Lever Representation Worksheet](#) encourages participants to come up with a way to solve this problem.

Each small group must then present its findings to the entire group. Activities #5, #6 and #7 provide the basis for this activity.

Design: Mystery Mechanisms (60 minutes)



Provide each group with a pair of scissors, a hole punch, paper fasteners, rubber bands, cardboard strips and squares. Present the mystery mechanisms you have made, with only the inputs and outputs showing. Their task is to create a mechanism that transforms the inputs into the outputs – in other words, the hidden innards of the mystery mechanism. In testing their model they can ask the following questions:

- ❑ Are the directions of motion of the inputs and outputs the same in the model as in the original?
- ❑ Is the range of motion similar in both?
- ❑ If the device returns to its original position when released, does the model do so too?

See Activity #9 in Mechanisms.

Sharing (10 min.)

Encourage participants to reflect on how they feel these activities would work in their classrooms, including modifications and changes they would make.



Workshop Tips and Strategies

Workshop Preparation

Collect as many mechanisms as you can find. Pp. 7-8 of Mechanisms and the City Technology web site, http://citytechnology.cuny.cuny.edu/Design_Mech.html, display a variety of common ones. Avoid the more complex devices, such as tape players and typewriters. You will also need to include some compound levers or linkages, for the first analysis activity. These are devices consisting of at least two levers, with one operating another. Examples are the folding chair, ironing board, nail clipper, vise grip, bicycle hand brake assembly, umbrella, tin snips, garden shears, pedal-operated wastebasket, pop-up book or card.

You will also need to collect and cut some cardboard, about two or three squares per group and six or eight strips. The most useful grade of cardboard for modeling is thin, with no corrugated layer, but stiffer than construction paper. Examples are shirt cardboard, file folders, Priority or overnight mail envelopes, oak tag, and pizza boxes.

Use these cardboard and brass paper fasteners to make the Mystery Mechanisms shown under “Workshop Materials”.

Brainstorming & Scavenger Hunt

Some participants may ask you to define exactly you mean by “a mechanism.” Defer answering this question until they have come up with some examples of things they might consider mechanisms.

Some mechanisms you can find in nearly any room are doors, doorknobs, locks, light switches, window latches, radiator valve knobs, folding tables or chairs. Office areas usually feature pencil sharpeners, staplers, staple removers, clipboards, binder clips, self-inking rubber stamps, and adjustable-arm desk lamps. In people’s clothing, handbags and briefcases, there are ballpoint pens, lipstick cases, safety pins, buckles, latches, and zippers. The human body includes numerous mechanisms, such as the upper arm, forearm, hand, fingers and thumb. As teachers collect items they think might be mechanisms, don’t express an opinion about whether any particular item really qualifies.

Once some devices have been identified that could be mechanisms, ask them to look for common features of these devices. Some focusing questions are:

- ❑ What do you have to do to operate it, and where on the device do you do this?
- ❑ What is the job it is intended for, and where on the device does this action occur?
- ❑ What happens between the point where you operate it, and the place where it does its job?

A reasonable conclusion is that a mechanism is a device that has visibly moving parts, and whose output is in a different place, and executes a different motion, from its input. Note that the first of these criteria excludes an electric circuit, whose only moving “parts” are electrons. The second rules out most push button switches, or a stick used to dislodge an item from a shelf, where the part you operate (“input”) is just an extension of the part that does the required job (“output”).

Sorting

Encourage the groups to select categories that are fundamental, such as type of motion, type of lever, or purpose; rather than superficial, such as color or type of material. As groups come up with different ways of sorting, you can highlight how their methods reflect different ways of thinking. For example, a group may come up with “Things that turn in a complete circle,” “Things that turn in a partial circle (arc),” and “Things that move in a straight line.” These are geometric categories. On the other hand, first-, second- and third-class levers, referring to the arrangement of the effort, fulcrum, and load, come under the general domain of science, because these categories focus on the underlying elements. Functional categories, such as, “things that grab,” “things that squeeze,” and “things that cut,” reflect a technology viewpoint, because they look at the purpose of the device. See p. 12 of Mechanisms.

Analysis 1

In presenting this activity, it is useful to spend a few minutes outlining some of the basic concepts, using some of the sample mechanisms as examples (see “Summary of Key Concepts”). Generally, teachers find it fairly easy to identify inputs and outputs. Some will claim that they can’t draw, but they can always trace them if necessary. Attempting to draw the mechanism forces one to look at it more carefully, and notice details that would otherwise be missed. If an overhead projector is available, provide transparency films and markers, and suggest that they present their drawings on the projector. The mechanisms themselves can be placed on the projector too, and operated there. The movement will appear magnified in silhouette on the screen.

Analysis 2

It is not so easy to find all of the levers in a compound device, and determining the class of each one. Suggest that they begin by holding one of the inputs steady, thereby isolating it from the moving parts. This will make it much easier to identify the remaining levers. It is helpful to outline each lever in a different color. For each one that they find, ask them to point out the effort, the fulcrum and the load, and label these in the same color on the diagram. Where one lever operates another, such as the handle of a nail clipper, which makes the upper jaw move, the load of the first becomes the effort of the second. (See P.47 of Mechanisms, especially Fig. 2-15.) The fulcrum is the pivot that the lever rotates around. Once the effort, fulcrum, and load of a lever are known, the teachers can compare their arrangement to the three classes on the reference chart, and determine the class of the lever they have found. Note that links with pivots at either end may not be levers at all, but simply connecting bars for keeping things in position.

The representation problem – how to show compound levers on the sorting list -- can be solved in a number of ways. Some participants may think of using a Venn diagram, showing a compound lever in the intersection between two lever classes, while others may prefer to use a grid, or simply a separate list of “Compound Levers.” If time permits, it is useful to compare these approaches.

Design

Some teachers find the mystery mechanisms to be a major challenge; many children find them much easier to figure out. Mechanisms #1 through #6, in the “Directions to Participants”, are arranged roughly in order of difficulty from easiest to hardest. Those who have done the Mechanisms activity of the Introductory Workshop may have already completed #1 and #2. Some participants will want to begin with the easiest, and gradually work their way through; while others may want to tackle the harder ones immediately. If teachers get stuck, a useful strategy is to refer them to the reference chart showing how the directions of motion at the effort and load are related for each of the three classes of lever. By comparing these with the motion they want, they can usually figure out what kind of lever to use.

As an additional challenge, you can suggest that a group add a return spring to its mechanism. It can be made using a rubber band. Another challenge is to explore alternative designs for each of the mechanisms. Also, each mechanism can lead to its own set of research questions: How can the range of motion be increased or decreased? How does the length and placement of a guide change the operation of a mechanism? What are the sources of friction that tend to hang the mechanism up, and how can friction be reduced?

Packaging & Other Structures

Summary of Key Concepts

Packaging includes any technology designed to protect, contain, display, dispense or transport something. Every package is an example of a **structure**. A structure is anything designed to keep objects in place, by resisting the **loads** that would try to shift them. Some structures are large, complex, and expensive, such as bridges, towers and buildings. However, most structures are fairly simple, cheap and easy to find. These include bags, boxes, furniture, shoes, ladders, wall fixtures, and items of all kinds that have been glued, taped, stitched, stapled, sewn or woven.



Most of the time, structures are taken for granted. Only when a structure stops doing its job - when it **fails** - do most people think about how the structure is supposed to work. A structure fails when it experiences loads (or forces) that are beyond its capacity. The loads that bear upon a structure fall into three main categories:

1. **tension** forces, which pull on a structure, trying to make it longer;
2. **compression** forces, which push parts of a structure together, tending to make it shorter and fatter;
3. **shear** forces, which shift opposite sides of a structure in opposing directions.

Different kinds of structures are designed to resist these three types of loads. Tension structures are often suspended from a point higher up, and designed to resist gravity. String, rope, wire, cable and chain are strong in tension, so they are often used for this purpose. Hammocks, light fixtures, clotheslines and belts are all examples of

tension structures. Compression structures typically rest on the ground or floor. They resist loads by “refusing” to be squashed appreciably. Some examples are the legs of a table, chair, or person; boxes supporting other boxes; canes, tires, and tree trunks. Points of attachment are generally designed to withstand shear. If one thing is not attached to another securely, they may shift in opposite directions, and the shear forces could win. A broken shoulder bag strap, which has pulled away from the bag, is an example of shear failure. Other examples occur when one side of something is moving and the other side is stationary, as with a broken CD case hinge, a torn-out shoelace, and the sheared-off side-view mirror of a car.

Most loads are not pure examples of tension, compression or shear, but involve some combination of the three. For example, a shelf works as a **beam**, supported at both ends, and subjected to a load somewhere in the middle. Because of the way it is supported and loaded, the top surface of a beam is compressed, while the bottom surface tends to get longer, and is therefore loaded in tension. For this reason, a broken craft stick has short broken fibers on the side where it was pressed, and much longer jagged fibers on the opposite side, which was in tension. Shear failure occurs here too, because these jagged fibers have to slip out of the natural adhesive that was holding them to the rest of the wood.

When a structure fails, it is not generally hard to determine whether it failed in tension, compression or shear. This analysis can be the basis for redesigning the structure to make it stronger, so it will be able to resist a larger load. To illustrate this point, we will discuss some of the failure modes of shopping bags. In each case, the type of failure suggests a remedy for strengthening the bag.

Flimsy plastic shopping bags usually fail when one of the handles gets longer and longer, and finally tears apart. Because it was due to pulling forces, this is an example of tension failure. When a taped handle of a paper shopping bag pulls out of its holder, the glue that held the handle in place has failed to resist the forces pulling the handle and bag in opposite directions. Therefore, this is a case of shear failure. A knotted-string handle may fail because the knot slips through the hole. This is an example of compression failure, because the knot was squeezed, making it smaller. Sometimes, the bottom of a paper bag gives way. The bottom of a bag functions as a beam. While its top surface is in compression, the bottom surface is subjected to tension. In some places, the paper might tear, which is an example of tension failure. In other spots, the glue might stop holding the two flaps together. Because the glue is supposed to keep the flaps from sliding in opposite directions, the weakening of the glue is an example of shear failure.

Pre-workshop Scavenger Hunt

Ask the participants to bring in any shopping bags they consider interesting or unusual.

Workshop Materials

- ❑ Rolls of pennies, or other appropriate weights. If penny rolls are used, you will need about thirty per group. Rolls are available from many banks, for 50 cents each. A box of fifty rolls costs \$25 and weighs about 20 lb. After the workshop, you can sell the pennies back to the bank.
- ❑ Masking tape; marked or cut into two-inch lengths.
- ❑ Fairly heavy yarn or cord, marked or cut into one-foot lengths
- ❑ Hole punchers
- ❑ Scissors
- ❑ Package of small brown lunch bags (at least two or three per participant)
- ❑ Large collection of shopping bags, with at least several of each of the following handle types: cut-out, knotted string, glue-on, drawstring, heat-sealed, and clip-on. Make sure you have enough cut-out, knotted string and glue-on types, and they are large enough, for each group to test a few of these by putting one or both feet inside.
- ❑ Transparency films and markers (if overhead projector will be available)
- ❑ Copies of Bag Design Worksheet and Bag Testing Worksheet (see next two pages)



Bag Testing Worksheet

Handle Type (select one) A. Cutout B. Taped C. Knotted-string	Prediction Make a drawing showing how you think it will fail.	Order Predict which bag will be strongest and weakest.	Test Results Make a drawing showing how it actually did fail.

Bag Design Worksheet

Bag Design Make a drawing showing the design that you tested.	Performance How many rolls of pennies did it hold?	Failure Mode Make a drawing showing how it failed.

Directions to Participants

The following five pages provide a set of instructions for the workshop activities, suitable for copying to transparency films, PowerPoint slides, or chart paper, for use during the workshop.

PACKAGING & OTHER STRUCTURES

1. Brainstorming & Scavenger Hunt

- List examples of packaging that could be acquired and brought into the classroom at zero cost.
- Look for examples of packaging in the workshop area, including your personal effects.

PACKAGING & OTHER STRUCTURES

2. Guess My Categories!

- Select a variety of shopping bags.
- Sort them according to your own group's **SECRET CATEGORIES**.
- The other groups will have to guess your categories.

PACKAGING & OTHER STRUCTURES

3. How do I Fail Thee?

(Let me Count the Ways!)

Select a few examples of the cut-out, knotted string and glued-on handles. For type:

- PREDICT how the bag will fail if used to carry too much weight.
- TEST the bag to see how it actually fails, by slowly pressing your foot in the bottom, while holding the handles. (Remove any shoes with pointed heels or soles).
- Use the Bag Testing Worksheet to RECORD your prediction for each bag type and COMPARE your prediction with the actual results of the test.

PACKAGING & OTHER STRUCTURES

4. Brown-Bagging it

Turn a brown lunch bag into a shopping bag using one of these methods – keep it simple, no reinforcements!

- The cut-out handles:

Cut a rectangular slot on each side.

- The taped-on handles:

Make handles of string or twisted paper, and tape a handle on each side.

- The knotted-string handles:

Punch two holes on each side, pass string through the holes on each side, and tie knots.

PACKAGING & OTHER STRUCTURES

5. Failure Leads to Redesign

- Test your brown-bag shopping bag by loading it slowly with penny rolls, until it fails. Note carefully how it failed and record how many pennies it held. Then redesign your bag, and make a new one, **CHANGE ONE THING ONLY**, using no more than 2 inches of tape.
- Repeat as many times as possible. Each time, use the Bag Design Worksheet to:
 - Record the improvement you made.
 - Record the total number of penny rolls.
 - Record the latest failure mode.

RULES: Each redesign cycle makes only one improvement, and uses no more than 2 in. of additional tape.

Sample Workshop Agenda

Introductions (10 min.)

Brainstorming and Scavenger Hunt (15 min.)

Divide the participants into small groups. Ask each group to list as many different kinds of packaging as they can. Every item on the list should be something they could obtain at no cost, and bring into the classroom. In addition, they should look for physical examples of packaging within the workshop area, and among their own personal effects. These might include boxes, bottles, book covers, envelopes, walls, windows, fruit peels, skin and handbags. Activity #1 in Packaging provides a basis for this activity.

Sorting: Guess my Categories! (30 min.)

Divide all of the available shopping bags among the groups. Include both the bags you have provided, any bags the participants have brought in as part of the pre-workshop activity, and any bags found during the scavenger hunt. Ask each group to sort their bags, keeping their categories secret. The other groups then try to guess the sorting principles used by each group. If none of the groups sorted according to the methods of construction of the handles, encourage them to sort again, using these as the categories. See Activity #2 in Packaging.

Analysis: How do I Fail Thee? (30 minutes)

Remove all of the shopping bags except for examples of these three types: the cut-out, glued-on and knotted-string handles. The task is to predict how each type of bag will fail, when loaded to its limit, and then to test each one to see how it actually does give way. In addition, they should predict which bags will be hardest to break, and which ones will be easiest. The Bag Testing Worksheet (p. 95) should be used to record all predictions and data. No group should actually test a bag until they have predicted what they think will happen. The test method is to hold each bag by its handles, put one foot in the bag, and then gradually apply pressure until the bag just starts to break. Participants should remove shoes with sharp edges, such as high heels, before testing. At the end of this activity, each group should present its data, including both predictions and outcomes of failure modes for each type of bag, as well as the relative strengths of the bags.

Modeling: Brown Bagging it (15 minutes)



This and the next activity are based on the teacher story found on pp. 96-99 of Packaging, and the further discussion on-line at:

http://citytechnology.ccnycuny.edu/Design_Packaging.html.

Ask each group to look carefully at the handles of three major types of shopping bags:

- ❑ **The cutout handles:** Found on the cheapest plastic bags, these consist of slots cut directly into the two sides of the bag.
- ❑ **The taped handles:** Found on cheap paper shopping bags, each of these is made of a separate piece of paper, which is added to the body of the bag, and held in place by a glued-on paper strip.
- ❑ **Knotted-string handles:** Found on glossy gift bags and fancy paper bags from upscale stores, these consist of a piece of string on each side, slipped through a pair of holes and knotted to keep each end in place.

After studying the various types of handles, each group is to select at least one of the three designs as a basis for turning a small brown lunch bag into a shopping bag:

- ❑ **The cutout handles:** Using a scissors, cut out a rectangular slot on each side of the bag.
- ❑ **The taped handles:** Tape on two eight-inch lengths of string, one on each side of the bag.
- ❑ **Knotted-string handles:** Use a hole punch make two holes on each side of the bag, near the top. Pass an eight-inch piece of string through the two holes on each side, and knot the ends so the string won't come out.

Some participants may interpret this activity as a contest to make the strongest bag. Strongly discourage them from attempting to reinforce or strengthen their bag in any way. Limit the amount of tape (for the taped-on handle only) to about two inches, and the amount of string (for tied and taped handles only) to two eight-inch lengths only, and do not allow any folding, knot tying (except for knotted-string handles), taping (except for taped handles) or any other reinforcing. In the next activity, they will be allowed to improve on these basic designs.

Design: Failure leads to Redesign (60 minutes)

This activity begins with the shopping bags created in the previous activity. The teachers load these bags with weights, such as rolls of pennies, to test their strength, by seeing how many weights they will hold. Each bag should be loaded gradually, until it fails.

Once the bag has failed, the group should use the Bag Design Worksheet to record the number of weights it held, and examine carefully how it gave way. They should look closely at any tears in the paper, points where the tape separated from the paper, or places where the string pulled through. Then ask them to redesign their bag based on a careful look at how their first design failed. For example, they may want to reinforce the places where the bag tore, improve the taping of the handles, or use more string, depending on what seems to be the weakest link in the original design. If they began by making rectangular cutout handles, ask them to compare their handles with those of commercial bags, which are always cut as circles or ovals. The redesign might consist simply of cutting different-shape slots.

Limit the amount of tape available for redesign to about two inches. Then they test their second design, again recording the number of weights held, and comparing the results with the outcomes from the first. This comparison will reveal how effective the modifications were. They should repeat this process, going through as many design cycles as time permits. Request that each group keep careful records of the failure mode at each stage in the redesign process, how many weights the bag held, and the changes they made to improve the design. Limit the additional amount of tape to two inches for each design cycle.

Do not discuss control of variables beforehand. This issue should come up in discussion during the course of the activity, or immediately afterwards. Activities #3 and #5 in Packaging develop lower- and upper-grade versions, respectively.

Sharing (30 min.)

Each group should share the results of their design activities. Specifically, they should describe the amount of weight and type of failure that occurred each stage in the design process, and explain what they did to redesign the bag. The concluding discussion could focus on the control of variables, as well as the role of design in the curriculum.

Workshop Tips & Strategies

Brainstorming and Scavenger Hunt

In the course of both activities, try to broaden the teachers' notion of what might qualify as a "package," which could include anything used to protect, contain and/or transport a solid, liquid or gas. Some examples would be natural packaging, such as fruit peel, human skin, egg shells, and cell walls; protective coverings of things, such as a suitcase, an appliance case, a pipe, a door, a window or a wall; nearly any article of clothing; string or tape used to hold something together; as well as balloons, bags, envelopes and nets.

Sorting

Some groups may sort according to superficial categories, such as color, style, printed message, paper or plastic, etc. Others may come up with construction method, ability to stand up, or whether the handles made of the same material as the bag. While these are more engaging categories, we find the method of making the handles to be the most interesting feature of shopping bags. We have identified six major types of handles, including the three described above under "Modeling." These are:

- ❑ **The cutout handles:** Found on the cheapest plastic bags, these consist of oval-shaped slots cut directly into the two sides of the bag.
- ❑ **The taped handles:** Found on cheap paper shopping bags, each of these is made of a separate piece of paper, which is added to the body of the bag, and held in place by a glued-on paper strip.
- ❑ **Knotted-string handles:** Found on glossy gift bags and fancy paper bags from upscale stores, these consist of a piece of string on each side, slipped through a pair of holes and knotted to keep it in place.
- ❑ **The heat-sealed handles:** thin plastic handles melted onto a bag made of the same flexible material.
- ❑ **The clip-on handles:** rigid plastic handles attached to a flexible plastic bag, one on each side, clamped on by tab-in-slot arrangements; and
- ❑ **The drawstring:** often found on bags from shoe stores and clothing stores, a single length of string is held by a heat-sealed hem around the top of the bag.

Of course, there are numerous variations that do not fit neatly into any of these categories. We have found bags with metal handles, rigid plastic handles that are heat-sealed, rather than clipped on, drawstrings made of plastic rather than string, etc. Also, bags vary considerably in the amount of reinforcement. Some knotted-string bags, for example, have as many as three layers of paper or cardboard holding metal grommets, so the string won't pull out! The intent of this activity is to focus participants on the basic categories, as well as some of the more interesting variants.

Analysis

Require each group to make a prediction before they test each type of bag. All predictions and actual outcomes should be written down. They may be represented by words and/or pictures. If possible, require the groups to share this data at the end of the activity.

Discourage participants from quickly pushing their feet through bags. By applying pressure slowly, they will make it more likely that the bag will fail at the weakest point only. Often, failure will occur at the handles rather than the bottom. It is useful to compare similar types of bags that have different level of reinforcement, such as knotted-string bags with and without metal grommets around the holes. Sometimes it will be clear how the reinforcement of the handle prevented it from failing before the bottom gave way.



Modeling

Emphasize that this is not a competition to make the strongest bag. By making their bags deliberately weak, they will learn far more about how bags actually fail, and be able to redesign their bag precisely to address the problems they uncover. If participants insist on reinforcing their bag, ask them how they know that their method of reinforcement actually makes the bag stronger, and if so, by how much. They should realize that they could answer these questions only by beginning with the simplest possible bag.

Redesign

This task uses the model from the previous activity as the baseline design. These bags will probably not hold much weight. Redesign proceeds by examining the mode of failure of the previous design, and trying to prevent it. Encourage the teachers to look

carefully at what happens as the bags begin to give way. Where does the paper tear? How does the tape begin to separate? Does the string break or does it open up the hole in the paper? These observations provide the clues for making the next design stronger. For example, bags with cutout handles are almost certain to fail at upper corners of the cutouts. An important issue worth highlighting is the way that forces become concentrated near sharp corners and edges. For this reason, a rectangular cutout will fail much sooner than an oval slot. Reinforcing the corners with tape will strengthen the bags considerably. If the teachers are careful in examining the failure modes, and reinforce precisely those parts that are weakest, their bags will improve dramatically with each redesign.

Encourage the groups to save the bags after they have failed, and to make a new one each time. An excellent way to present the data from this activity is to line up all the broken bags in order, with a record of how many penny rolls each one held.

Once the teachers begin testing bags, there may again be pressure to compete over who can make the strongest bag. Strongly discourage this idea, and strictly limit the amount of tape available for each cycle of redesign. The purpose of the activity is to examine closely how incremental improvements affect the strength of the bag and shift the failure mode from one point to another. Each redesign should be based only on the failure of the previous one, and not on imagining what will make the strongest bag. Trying to make a strong bag immediately short cuts all of the learning about structures, and the role of failure in design (see “The Role of Failure in Design” in Chapter 4 of this [Guide](#).)



Sharing

A good way to underscore the purpose of the design activity is to require each group to keep careful data, and to share it at the end. For each step in the redesign process, they should be able to explain:

- How the previous design failed;
- What they did to improve the design, based on their examination of the failure mode; and
- How many more units of weight the new design held compared with the previous one.

Beyond the basic data from the tests, these activities provide opportunities to discuss some important issues in design. You might point out that the limitation to two inches of tape is an example of a design constraint. How did this constraint affect the design process? What sorts of constraints do commercial shopping bag designers have to observe? What criteria do they aim for?

Signs, Symbols & Codes

Summary of Key Concepts

All **communication** is accomplished using symbols. A **symbol** is something used to convey a meaning. It could represent an idea, an action or an object. People are able to create symbols using written marks, such as punctuation, letters, numbers, and arithmetic operation signs; pictures; gestures or other body motions, such as tapping someone on the shoulder; and sounds, including both spoken language and non-verbal utterances, such as “mmm ...” and “uh huh.” There are also symbols generated by electrical or mechanical devices, such as horns, traffic lights, computers, radio transmitters, telephones and doorbells. Symbols generated electrically or mechanically are sometimes called **signals**. These include gestures; for example, putting a finger over one’s lips is a signal for “Quiet!”



When people communicate, they have to use symbols, because these provide the only clues about what we are thinking. For communication to work, both the originator and the receiver have to agree on what the symbols mean. A language is a system of symbols with generally agreed-upon meanings. There are also graphic symbol systems, such as the set of symbols used on a map, for musical notation, to indicate chess pieces, to describe cross-stitching patterns, etc. A symbol system that does not use words is called a **code**. Some codes use numbers, such as Zip Codes and ISBN’s, while others use gestures, such as the football referee’s signaling system. Braille is a tactile code for representing letters and numbers. Bar codes are patterns designed to be read by optical scanning machines. A **key** shows the translation between a code and ordinary language.

How are the meanings of symbols established? There are two basic methods. Some symbols imply their own meaning, by using images or sounds that correspond in some way to the concepts they represent. For example, a “Wheelchair Access” symbol shows an icon of a wheelchair, which would be recognized by most people. Symbols of this kind we call **expressive symbols**. Other symbols, such as the letters of the alphabet, have no logical connection at all with the things they refer to. These we call **arbitrary symbols**. People can usually figure out expressive symbols for themselves, but arbitrary symbols simply have to be memorized.

Communication breaks down when the sender and receiver interpret the symbols differently. This can happen because a symbol has more than one meaning, more than one symbol has the same meaning, or the receiver simply hasn’t learned the meaning in the same way as the sender. When a symbol has more than one meaning, the alternate meanings are called **homonyms**, by analogy with two words that sound the same but have different meanings. Homonyms can be confusing, because the sender may have intended one meaning for a symbol, while the receiver assumes another. If someone is unsure about the intended meaning of a symbol, they generally try to use clues from the environment, i.e., the **context**, to clear up the uncertainty. A more subtle problem occurs when more than one symbol has the same meaning. We call the alternate symbols **synonyms**, again by analogy with spoken or written language. The problem here is that the receiver may associate a particular synonym with the meaning, and not expect another. Here again, context is crucial in establishing that a particular symbol is being used to convey a particular meaning. Frequently, children lack the contextual clues assumed by adults, or vice versa, which can lead to a breakdown of communication between them. How many adults understand the shorthand language children use in on-line chats?

Much of education consists of learning to create messages in various symbol systems, and translating among them. For example, learning to read means learning to translate from written language both to spoken language and to the concepts represented by language. Arithmetic “word problems” require translation from written language to mathematical shorthand. Errors in translation often occur because math teaching focuses more on the **syntax** – the structure of the language – than on the **semantics** – what the symbols actually mean. For example, the statement “There are three times as many dogs as cats” is mistakenly translated syntactically as $3D = C$, while the correct equation would read $D = 3C$.

Symbols qualify as technology, because they are invented by people to solve problems. Like other forms of technology, they can be analyzed to see how well they accomplish their purposes, and redesigned if found wanting. An evaluation question for a symbol is: *“Does it convey the intended meaning?”* A typical symbol has a variety of elements that work together, and these elements can be identified and analyzed separately. For example, the commonly encountered “NO SMOKING” symbol includes a circle, a diagonal bar, a cigarette, and smoke. It uses particular colors, line widths, and sizes for the various parts. In analyzing a symbol, it is useful to ask how well each of the elements contributes to the overall goal.

Pre-Workshop Scavenger Hunt

Ask participants to find:

1. Symbols that are especially hard to figure out, and
2. Symbols that would be widely understood, even by people from different cultures.

Workshop Materials

- A collection of discarded newspapers and magazines
- Index cards
- Clear tape or glue stick
- Maps and floor plans from museums and/or zoos
- At least one secret message per group, written on an index card. These messages should be fairly easy to represent graphically, but not commonly found on signs, which would make them too easy. Sample messages are:
 - There is a hole in the sidewalk.
 - The toilet is broken.
 - Low ceiling -- don't bump your head.
 - No running in the hallways.
 - Please take a number and be seated.
 - Please knock before you enter.
 - This way to the exit.
 - Please stand on line.
 - Bicycle crossing.
 - Stairway closed for repairs.
 - Hole in the sidewalk -- be careful.
 - All turns from right lane.
 - No riding on luggage carts.
 - Quiet -- people studying.
 - No food or beverages.
 - No littering.
 - Caution -- wet floor.
 - Jacket and tie required
 - Do not close the window.
- Possible props for designing graphic instruction manuals, as available: yarn or string for knot tying, cat's cradle, weaving or braiding; construction paper; cardboard; scissors; a yo-yo; playing cards for card tricks; handkerchiefs or thin scarves for juggling; jump rope; rubber bands, barrettes or "scrunchies" for hair

braiding; strong lamp, slide projector, or overhead projector for making shadow animals; buckets for use as drums

- Overhead transparencies and markers (if projector is available)
- Copies of Symbol Analysis Worksheet, Symbol Design Worksheet, and Graphic Instruction Manual Worksheet (see next three pages).

Symbol Analysis Worksheet

Good Symbols	
Symbol	What Makes it Good
Bad Symbols	
Symbol	What Makes it Bad

Symbol Design Worksheet

Original Design	
Sketch your symbol	Difficulties the testers had in using it:
After Redesign	
Describe the features you added in each redesign:	Remaining Difficulties with each redesign:

Graphic Instruction Manual Worksheet

Original Design		
Point at which testers “got stuck”	Problems that had to be addressed	
After Redesign		
Describe the features you added in each redesign:	Point at which testers “got stuck”	Remaining Difficulties with each redesign:

Directions to Participants

The following five pages provide a set of instructions for the workshop activities, suitable for copying to transparency films, PowerPoint slides, or chart paper, for use during the workshop.

SIGNS, SYMBOLS & CODES

1. Scavenger Hunt

- Look through some newspapers or magazines.
- Cut out and save any symbols you find.
- To avoid losing small ones, you can tape or glue them to index cards.
MOUNT ONLY ONE SYMBOL PER CARD, so you can sort them later.

SIGNS, SYMBOLS & CODES

2. Guess my Categories!

- Sort your symbols according to SECRET CRITERIA.
- The other groups will have to guess these criteria.

SIGNS, SYMBOLS & CODES

3. The Good, the Bad & the Ugly

- Look through a museum floor plan, a zoo map and the symbols you have already collected to find:
 - A few whose meaning is obvious;
 - Some that are ambiguous or hard to interpret

- Decide:
 - What makes the good ones good?
 - What gets in the way of understanding the bad ones?

Show the good and bad symbols, and your conclusions about them, on the Symbols Analysis Worksheet.

SIGNS, SYMBOLS & CODES

4. Design your own Symbol

- Each group will receive a SECRET MESSAGE. Your task is to design a symbol that conveys this message USING NO WORDS.
- Then try it out on another group to see if they can figure out what it means.
- DO NOT REVEAL THE MEANING. Instead, listen closely to discover the features of your symbol that make it unclear.
- Redesign your symbol based on this data, and try it out again.

Use the Symbol Design Worksheet to record all data.

SIGNS, SYMBOLS & CODES

5. Graphic Instruction Manuals

- Select a task that a member of your group knows well, but that most people don't know how to do.
- Everyone in the group should learn the task. Then design a graphic instruction manual that teaches the task, **USING NO WORDS**.
- Ask another group to follow your manual, **BUT DO NOT COACH THEM**. Note carefully how and where they have difficulty.
- Now, redesign your manual to address the problems, and try it again.

Use the Graphic Instruction Manual Worksheet to record all data.

Sample Workshop Agenda

Introductions (10 min.)

Scavenger Hunt (10 min.)

Provide each group with a collection of discarded newspapers and magazines. Their task is to cut out and save as many symbols as they can find in these printed materials. To avoid losing small pieces, they can mount them on index cards with tape or glue. Only one symbol should be mounted on a card, so they can be sorted in the next activity. See Activity #1 in Signs, Symbols & Codes.

Sorting: Guess my Categories! (30 min.)

The groups should swap their collections of symbols, so that the symbols they use for this activity are not the same ones they have collected during the scavenger hunt. Then ask each group to sort its new set of symbols into several categories of their choice. They are to keep these categories secret from the other groups. After they have finished sorting, each group is to invite another group over to inspect their newly arranged symbols. The visiting group must try to guess the categories that were used.

Analysis: The Good, the Bad and the Ugly (30 min.)

This activity is based on Activity #4 in Signs, Symbols & Codes. Provide each group with a few maps or floor plans, for example, from a museum or zoo. Their task is to analyze several of the symbols used on these maps to determine how well they convey their intended meaning. They should also include any “bad symbols” and universal symbols they have found in the Pre-Workshop Activity. Would all people interpret these symbols the same way? Or do they assume some kind of background information, such as familiarity with written English, or with particular objects, such as a traditional-style telephone? Also, does each of the symbols represent the same idea in the same way? If not, which ones work better, and why? What elements of a symbol make it easy or hard to figure out? The Symbol Analysis Worksheet can be used to keep records.

Design I: Design your own Symbol (30 minutes)

Explain to each group that they must convey their message by creating a sign that does not use any words. The other groups will then test the sign by trying to figure out the original message, only by looking at the sign. The group that created the sign should not coach the testers in any way, but simply listen as they try to figure out what the sign means. Based on the difficulties the testers encounter, the designers should then redesign their sign, and try it out again. The Symbol Design Worksheet should be used to keep track of each design cycle. See Activity #5 in Signs, Symbols & Codes.

Design II: Graphic Instruction Manuals (45 minutes)

Make the groups aware of the props that are available for this activity, such as string, scissors, playing cards, tennis balls or handkerchiefs (for juggling), buckets (for drumming), construction paper, a yo-yo, etc. Each group is to select a task that one member of the group knows well, but that most people probably don't know how to do. The person who knows the task should first teach it to the rest of the group. Then the group should design a graphic instruction manual for performing this task. The manual may not include any words. Some tasks that could be used for this activity are:

- How to make a paper airplane or boat
- How to make a paper hat or mask
- How to do origami
- How to make a "fortune teller" from a sheet of paper
- How to make a house of cards
- How to make cardboard doll house furniture
- How to make a paper pop-up mechanism
- How to tie a special kind of knot
- How to braid or weave with yarn
- How to braid hair
- How to play cat's cradle
- How to do a yo-yo trick
- How to jump rope
- How to do sleight-of-hand with coins, currency or cards
- How to juggle
- How to execute a ritual handshake
- How to play a drum melody on overturned buckets
- How to do a dance step
- How to do a hand-slapping/finger-popping routine
- How to make shadow animals
- How to do an exercise routine

Once the manual has been developed, members of another group will attempt to perform the task, using only the graphic instruction manual as a guide. As in the previous design activity, the designers of the manual should not coach or prompt the testers in any way, but simply watch as the testers try to decode the instructions. Based on the difficulties they encounter, the creators of the manual should then redesign it, and try it out again, and repeat the redesign cycle as many times as needed. The Graphic Instruction Manual Worksheet will help participants organize their data. See the Extension to Activity #5 in Signs, Symbols & Codes.

Sharing (10 min.)

Each group should share the results of both their analysis and design. Encourage them to reflect on how they feel these activities would work in their classrooms, including modifications they would make.

Workshop Tips and Strategies

Scavenger Hunt

Symbols are extraordinarily commonplace, and they appear in a wide variety of guises. One objective of this activity is to broaden the teachers' thinking about what qualifies as a symbol. Encourage the teachers to be as inclusive as possible in their working definitions of "symbol."

Sorting

Because the world of symbols is so diverse, this activity requires considerable discussion and creativity. Here are some categories teachers have come up with:

- ❑ Commercial symbols
- ❑ Symbols that represent a nation, religion, or public institution
- ❑ Universal symbols; i.e., those designed to be recognized across culture and language barriers
- ❑ Implicit symbols in clothing, beverages or cars
- ❑ Self-evident symbols, such as arrows and "happy faces"
- ❑ Symbols that are part of written language, such as letters, numbers and punctuation marks

Often, these categories are not mutually exclusive, so that some items belong to more than one category. In other words, there may be an intersection set that includes items from two or more categories. Furthermore some categories may be further subdivided into subcategories, or subsets. Some participants have drawn Venn diagrams to show the relationships among the categories, which is an excellent math connection to this activity.

To speed up the process of determining whether or not the guesses were correct, some workshop leaders have suggested that participants write the name of each category on an index card, and leave it face down as other groups come around to guess their categories. After guessing a category, they can look at the index card to see if they were right.

Analysis

If teachers have difficulty getting started with this activity, it may be helpful to ask some focusing questions:

- ❑ What concept does this symbol represent?
- ❑ Does the symbol need to be learned, or is its meaning already obvious?

- ❑ What graphic devices does it use? (e.g., lines, arrows, arcs, circles, colors, punctuation marks, pictures) What meaning does each of these elements convey?
- ❑ Could this symbol have more than one meaning?
- ❑ Could another symbol have the same meaning as this one?
- ❑ Can you think of a way to make it clearer?

Design I

In this activity, participants design a symbol to convey a particular message, and then test it by seeing whether others can determine the message. In a professional design context, this would be called the “meaning-for-symbol test”. The sign they create may not contain any words. Participants may ask whether letters, numbers or punctuation marks are allowed. The answer is “yes” in each case, because these are not words.

It is important to emphasize that the test is of the symbol, not of the people testing it. In other words, the purpose of the test is not to see how clever the testers are, but rather to evaluate the symbol itself, and gather data for redesigning it. Therefore, the designers should not provide any hints or clues, but instead should listen carefully as the testers try to figure out their design. Any misunderstanding or confusion provides valuable data for the next design cycle. If a group produces a sign that others are able to figure out immediately, provide them with another, more difficult message to convey.

Design II

Nearly everyone has some special kind of skill that most other people have never learned. In creating this instruction manual, they rely entirely on the use of graphic symbols to teach their skill to others. The designers of the manual will have to make some assumptions about the audience: which way they are facing, how nimble they are, how a two-dimensional representation of motion translates into three dimensions, etc. Assist the groups in coming up with appropriate tasks, but leave them pretty much on their own in their design of the manual. They will then test the manual by seeing if others can follow it. In the graphic design world, this is called the “function test.”

As in Design I, emphasize that the test is of the manual, not of the testers, and that the purpose is to gather the data needed for redesigning it. The designers should watch carefully as others try to go through the motions they think they have communicated, and find out exactly where the instructions fail to convey their intended meaning. Most participants will be surprised at how difficult it can be to convey this kind of information graphically. The process of testing the manual usually makes reveals its shortcomings immediately. Using this information, they should then redesign the manual to try to correct its weaknesses, and try it out again.