

Chapter 1

APPETIZERS

This chapter will help you get started by suggesting ways you can learn about mechanisms and other systems for yourself. Some of the ideas will also work with your students later on, but for now the focus is on you. By trying out some of the activities in this chapter, you will become much more familiar with the topic and see its potential for your classroom.

Watch a carousel. What makes the horses go up and down? Look closely at a toddler's pull-toy. As you pull it horizontally, parts of it move up-and-down and maybe even sideways. How does this happen? Open an umbrella. When you release the catch, how does this allow the ring to slide up the shaft? As you move the ring up, how does it make the skin of the umbrella stretch outward and open?

Mechanisms All Around

The carousel, pull-toy, and umbrella are all examples of *mechanisms*, or devices with moving parts. A good way to prepare yourself for teaching mechanisms is to look for mechanisms in your own life. Think of it as a scavenger hunt. Here's a list of common mechanisms you have a good chance of finding at home or at school. Later in the chapter, we'll take a close look at some of these devices and suggest some simple ways to analyze how they work.

- **Kitchen mechanisms:** arm-operated corkscrew, rotary can opener, jar opener, nutcracker, pedal-operated wastebasket, egg beater, ice-cream scoop, toaster, tea-kettle spout, coffee maker, garlic press, egg topper, pizza tray holder, garlic peeler, jar opener, crank-operated peeler, juicer, salad spinner, mixer, blender
- **Bathroom mechanisms:** nail clipper, eyelash curler, tweezers, retractable mirror, scale, electric razor, hair dryer, spray cleaner, toilet, faucet, adjustable shower head
- **Classroom mechanisms:** hole puncher, scissors, pencil sharpener, retractable ballpoint pen, bulldog clip, clamp-on binder, ring-binder opener, clipboard
- **Office mechanisms:** adjustable desk lamp, stapler, staple remover, self-inking rubber stamp, typewriter, postal scale, copy machine, fax machine
- **Fold-up mechanisms:** folding chair, folding table, ironing board, baby carriage, shopping cart, umbrella, luggage cart, clothes drying rack, sewing box with expandable trays, foldable collator

Mechanisms & Other Systems

- **Yard mechanisms:** lawnmower, lawn sprinkler, pruning shears, gate latch, hose spray attachment, snow thrower, hedge clipper
- **Appliance mechanisms:** VCR, tape player, sewing machine, watch, clock, camera, rotary-dial phone, record player, oscillating fan, retractable-cord vacuum cleaner, steam iron with sprayer
- **Computer mechanisms:** printer, scanner, CD ROM drive, disk drive, mouse, trackball
- **Bicycle mechanisms:** pedal, chain-and-sprockets, handbrake, gearshift, derailleur, pump, bell, speedometer
- **Door and window mechanisms:** deadbolt lock, automatic door closer, casement window crank opener, venetian blind, window shade
- **Toy mechanisms:** windup toy, pull toy, pop-up, yo-yo, Rubik's cube, Jacob's ladder, toy car, transformer, flexible action figure, water gun

Obviously, there are many more possibilities. Look around!
How many more items can you add to the list?

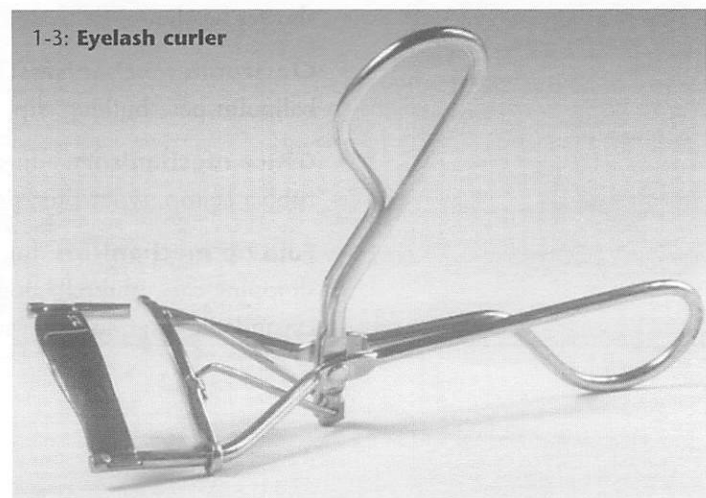
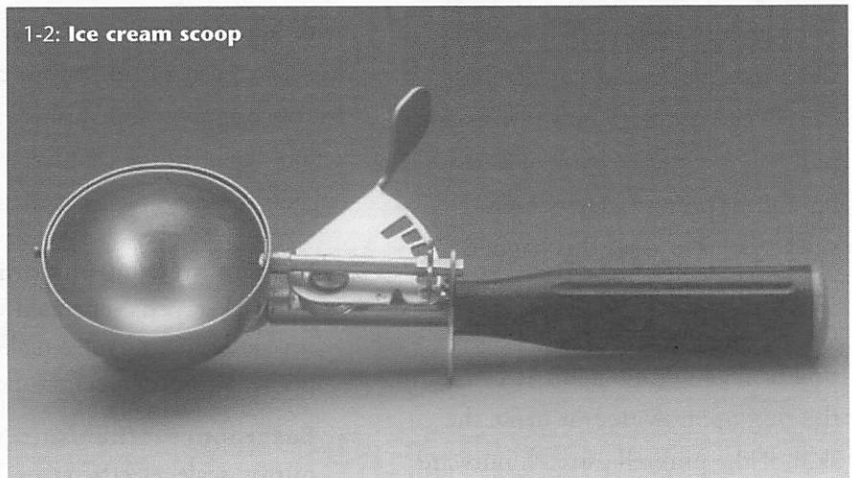
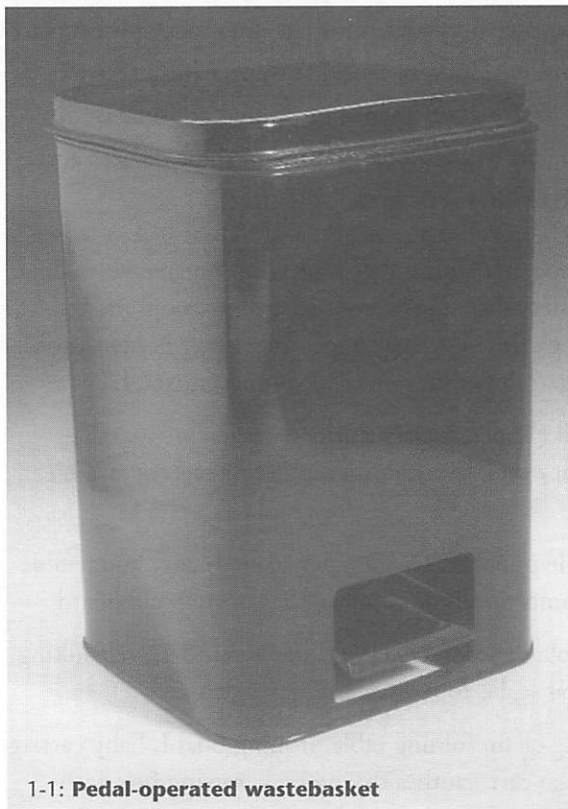

1-4: Pencil sharpener

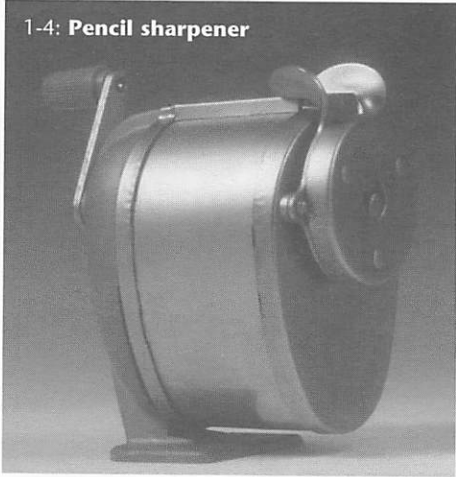

1-5: Foldable collator

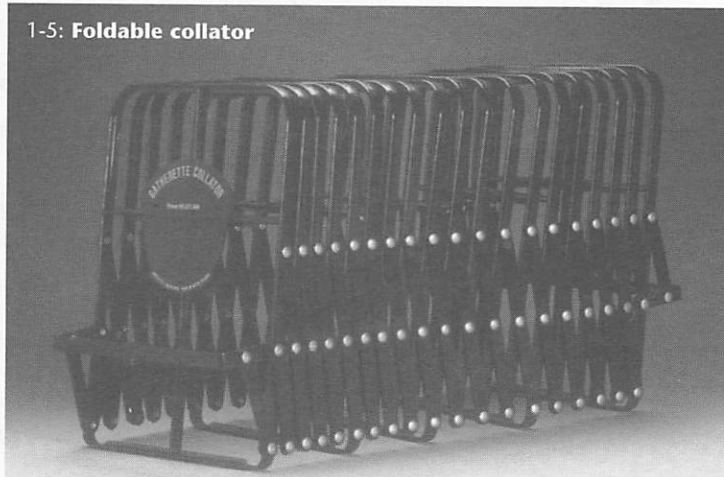

1-6: Umbrella



1-7: Egg topper

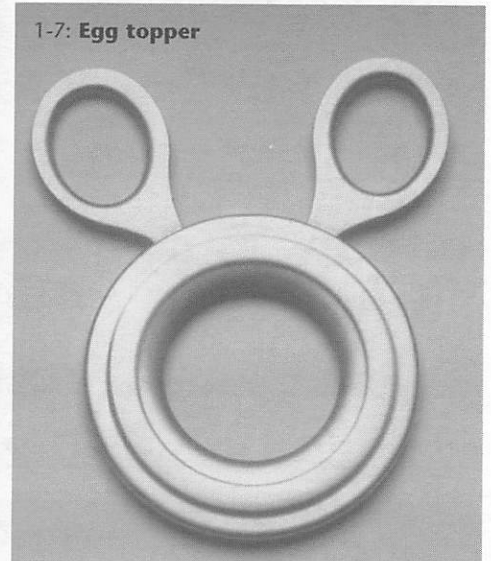

Mechanisms & Other Systems

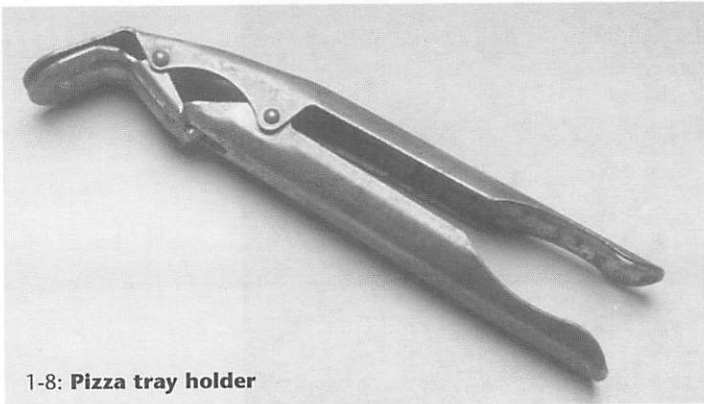

1-8: **Pizza tray holder**

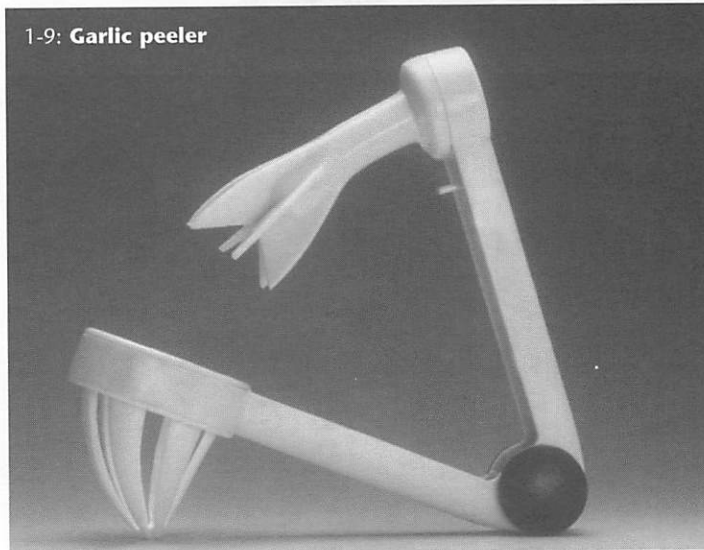

1-9: **Garlic peeler**

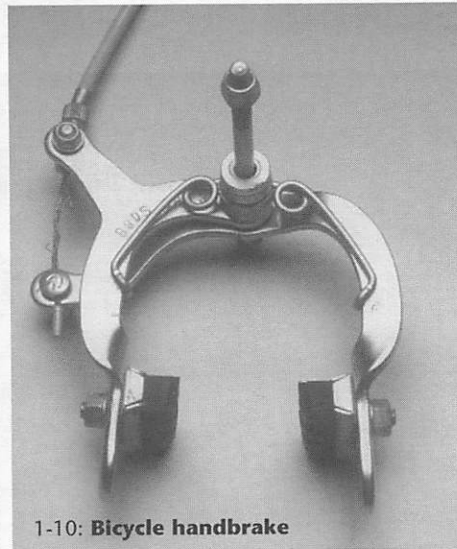

1-10: **Bicycle handbrake**

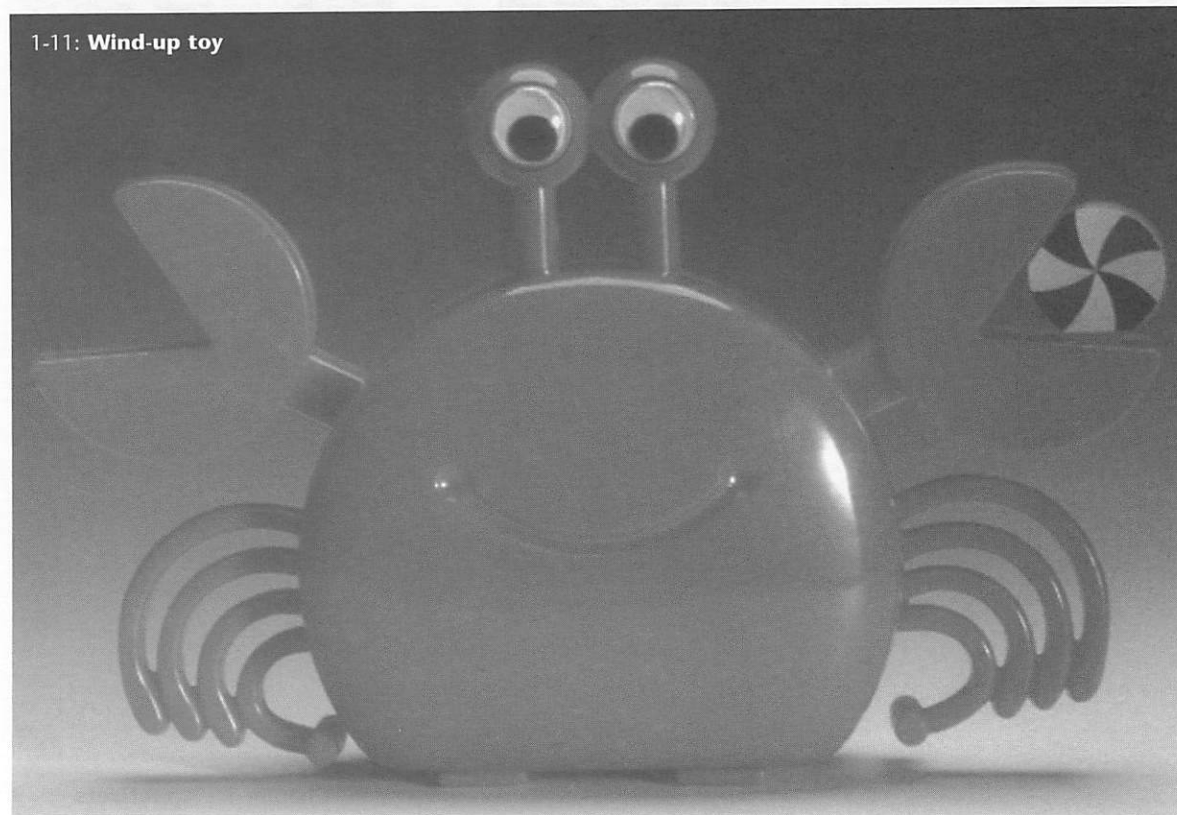

1-11: **Wind-up toy**

Tips for Mechanism Collectors

You can find a lot of simple mechanisms just by looking around at home and at school. But don't stop there.

The trash is an excellent source for appliances and computer equipment.

This stuff is free, it's often in good mechanical condition (though obsolete or missing parts), and you don't have to worry about breaking it when you take it apart to see how it works.

Schools throw out obsolete office and computer equipment from time to time.

Ask the school custodian where large items are stored before being disposed

of. Try to arrange to have him or her notify you when an item of interest is thrown out.

Other good sources are the basements of apartment buildings, shopping malls, community centers, churches and synagogues. Most custodial staff people are more than happy to cooperate if you explain your needs to them.

Look around your neighborhood and town. Many towns and cities have bulk trash pick-up days when people are allowed to put larger items on the curbside. It may be worth spending

a few dollars if you spot a hard-to-find item of particular interest at a tag sale, street fair, or flea market. Those are good places to get typewriters, old cameras, rotary-dial phones, and phonographs without spending a lot of money.

Removing just a handful of screws or prying off outer plates and housings is usually all it takes to expose the mechanism. That often means the device's working days are over. Before you take anything apart, make sure no one cares about it or intends to use it again.

to find out how the mechanisms in complicated devices work, you have to take them apart. For that you'll need a few screwdrivers. If you don't already own some, pick up both a set of full-size flat and Phillips screwdrivers and a pocket set of precision screwdrivers, again including both standard and Phillips varieties. The full-size screwdrivers come in handy for taking apart larger items like printers, sewing machines, and typewriters; the little ones are good for taking apart cameras, wind-up toys, cassette tape players, and the like.

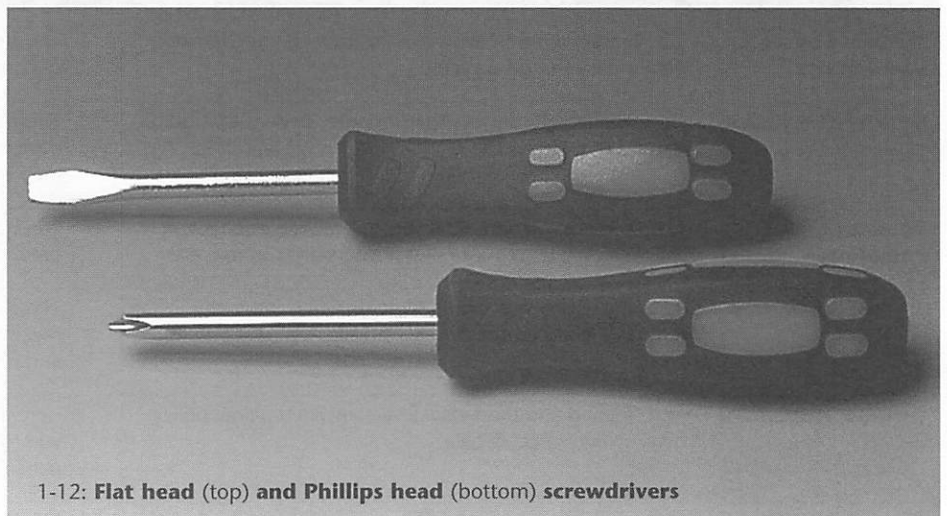

1-12: Flat head (top) and Phillips head (bottom) screwdrivers

Sorting Your Collection

A useful and enjoyable way to begin making sense of your collection is to think about different ways of sorting the mechanisms you have found.

When children engage in sorting activities, they are developing and exercising some of the most basic science process skills: exploring similarities and differences, defining categories, and classifying. There is also a practical reason for sorting:

if you have to store your mechanisms for later use, classifying them first will make it much easier to find the ones you want.

How to establish categories for sorting depends on the nature of your collection and also on some basic philosophical decisions. Before reading further, think about how you would answer these questions: What principles should determine categories for

sorting? Should mechanisms be understood in terms of what they do or in terms of their most basic components? The first method adopts a *technology* perspective, because it focuses on the purpose of the device, from the user's point of view. The second approach is typical of science; it analyzes the device down to its fundamental parts.

Table 1-1

SIX WAYS OF SORTING MECHANISMS

Principle	Typical Categories	Comments
By type of user, place of use	Toy, kitchen utensils, bathroom, outdoors, male/female, architectural hardware, etc.	This was the principle used in categorizing the brainstorming list above.
By overall function	Devices that cut, devices that squeeze, devices that grab, devices that fasten, etc.	These are categories that describe the purpose of the device as a whole. The mechanisms are seen as a means to an end.
By degree of complexity	Simple levers, compound levers, more than one type of simple machine, requires one or two hands to use, etc.	This is an easy way to start, because it involves less background knowledge than most of the other methods.
By type of motion	Parts that move in a straight line (linearly), parts that rotate, parts that oscillate (rotate back and forth)	These categories are based on the geometry of a mechanism. They require you to trace the moving parts, and understand the paths they follow (see next chapter).
By type of machine	First, second and third class levers, inclined plane, pulley, gear, screw, wheel & axle.	Here are the classic "science categories" which require you to reduce a mechanism to its simplest component parts (see next chapter).
By purpose of each element of the mechanism	Change the location of motion, change the type of motion (e.g., from linear to rotary), amplify force, amplify range of motion	These are more technical categories, which reflect an analysis of why the designer chose a particular mechanism in each case (see next chapter).

Table 1-1 suggests half a dozen ways of sorting mechanisms. The first three require little or no background knowledge, while the last three depend on some analysis of mechanism types and motions. These topics are covered in detail in the next chapter.

Looking Closely at the Mechanisms

Now it's time to focus on how the mechanisms in your collection work. We suggest you begin with a fairly simple mechanism, such as an eyelash curler. If you don't already have one, you can buy one at a drugstore for about \$2. Move the handles back and forth a few times to get a sense of how the curler works. Look closely at the two "extreme positions"—when the curler is fully open and when it is completely closed. These positions are illustrated in Figures 1-13 and 1-14.

Take a closer look at the mechanism. Hold one handle in one hand. Move the other handle with the other hand. Notice that the V-shaped arm (marked by arrow) also moves, pushing the lower grip toward the fixed upper one. When you use the device this way, the handle you move is the *input*, and the grip that closes is the *output*.

The ice-cream scoop is another simple mechanism. Figures 1-15 and 1-16 show the scoop in its open and closed positions, respectively.

The thumb lever, which is the input, is at the end of a triangular plate with a series of slots cut into it. When you push on the lever, these slots turn a little gear, which is attached to the C-shaped slicer (see arrow) by a shaft. The slicer is the part that cuts a scoop of ice cream away from the bowl to release it. Can you find the spring that returns the lever and slicer to their original positions when you remove your thumb?

1-13: Eyelash curler, open position

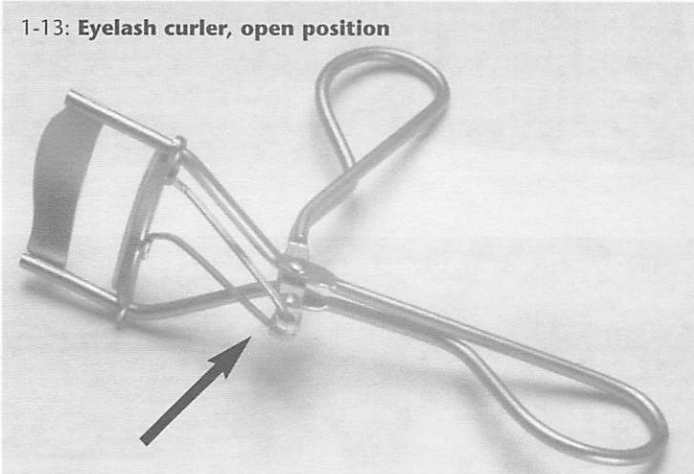

1-14: Eyelash curler, closed position

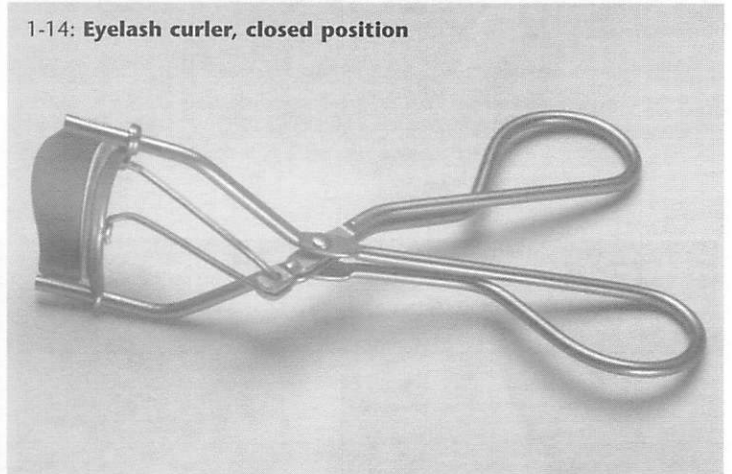

1-15: Ice cream scoop, open position

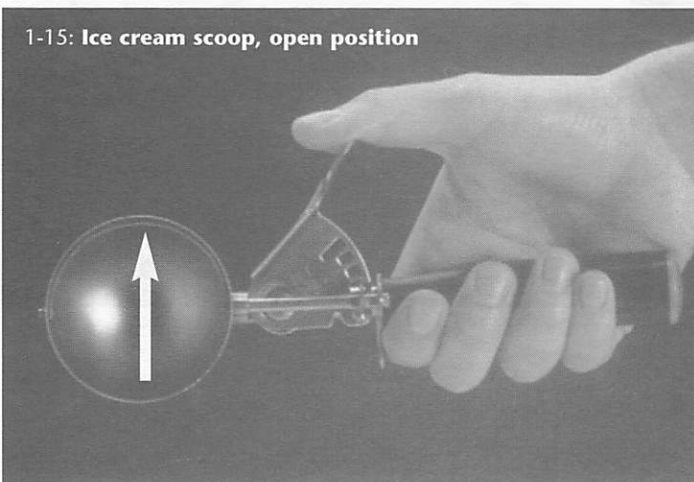

1-16: Ice cream scoop, closed position

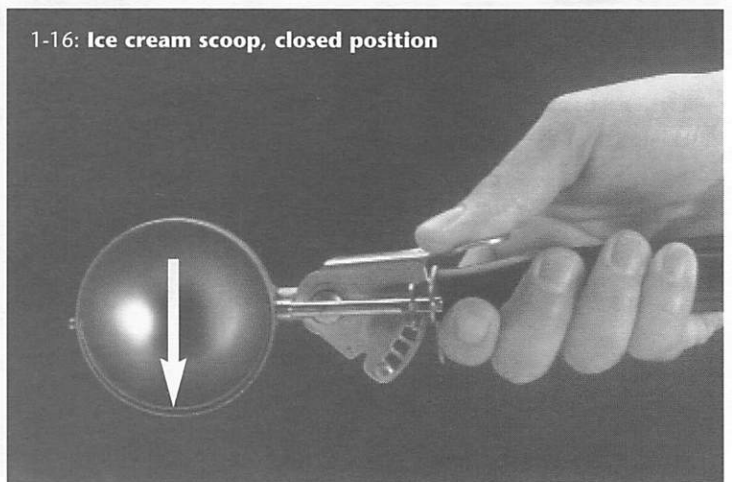

Mechanisms & Other Systems

Many mechanisms are much too complicated to analyze completely, but not too hard to figure out in little pieces. Figure 1-17 shows a tape cassette player. When the “EJECT” button is pressed, a little door pops open, releasing the cassette. What makes it do so? By

removing a few screws, it is not hard to find out. Figure 1-18 shows the same tape player with the cover removed, nearly ready to be examined to see how the “EJECT” mechanism works. In Figure 1-19, you can see the main body, removed from the case. The

“EJECT” button is at the top left. When this button is pressed, as in Figure 1-20, the long rod (see arrow) just under the frame moves to the right, forcing up the latch that opens the door holding the cassette.

1-17: Cassette tape player with finger on the “EJECT” button



1-18: Cassette tape player, partly disassembled

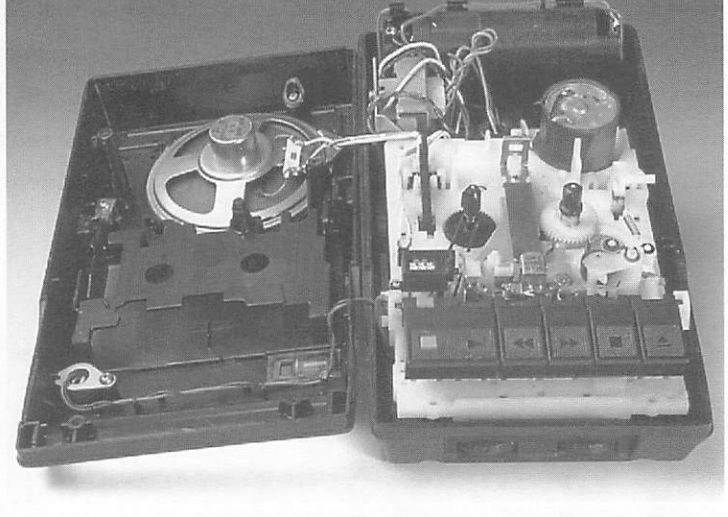

1-19: Inside of cassette tape player, door in “closed” position

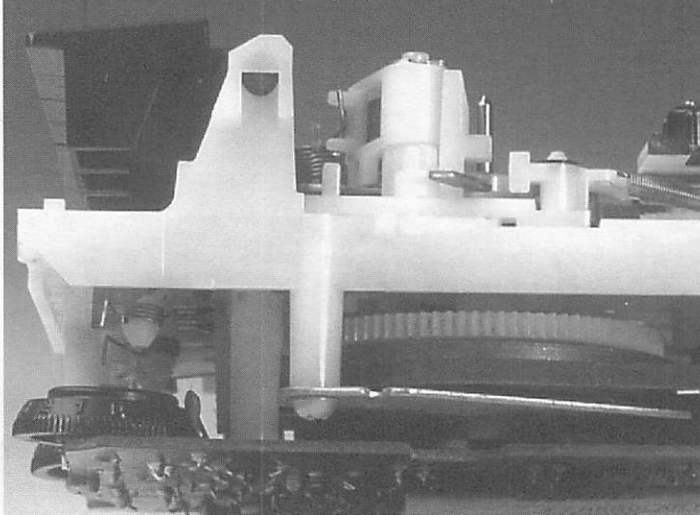

1-20: Same view as 1-19, door opened by “EJECT” button

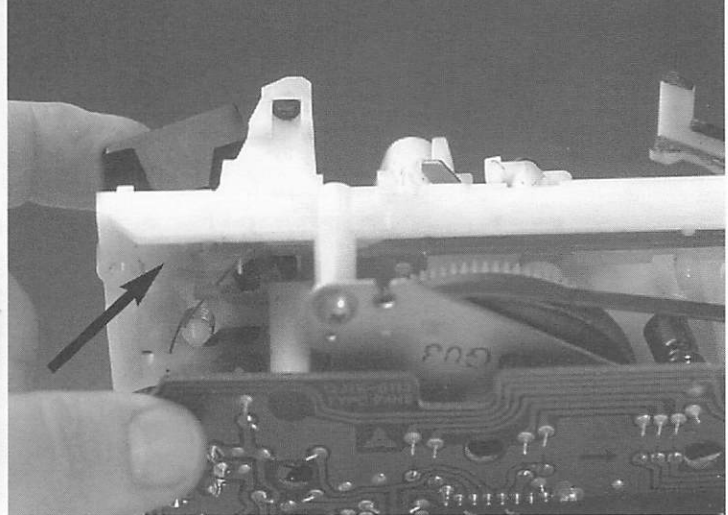

What's Inside of Me?

Hidden Mechanisms

Here are some challenges presented in increasing order of difficulty. The inputs and outputs in the following devices are obvious, but the mechanisms are concealed. Can you imagine and sketch what's going on inside of them? The answers are presented later. Right now, your challenge is to try to figure these out on your own.

Challenge #1: The Deadbolt Cylinder Lock

The common deadbolt lock shown in Figure 1-21 poses a little problem. Turning the handle or the key causes the bolt to slide up or down inside the two catches on the left. What happens inside to convert a turning motion to a straight-line motion? What holds the mechanism in the locked and unlocked positions until the key or the knob is turned?

1-21: Deadbolt cylinder lock

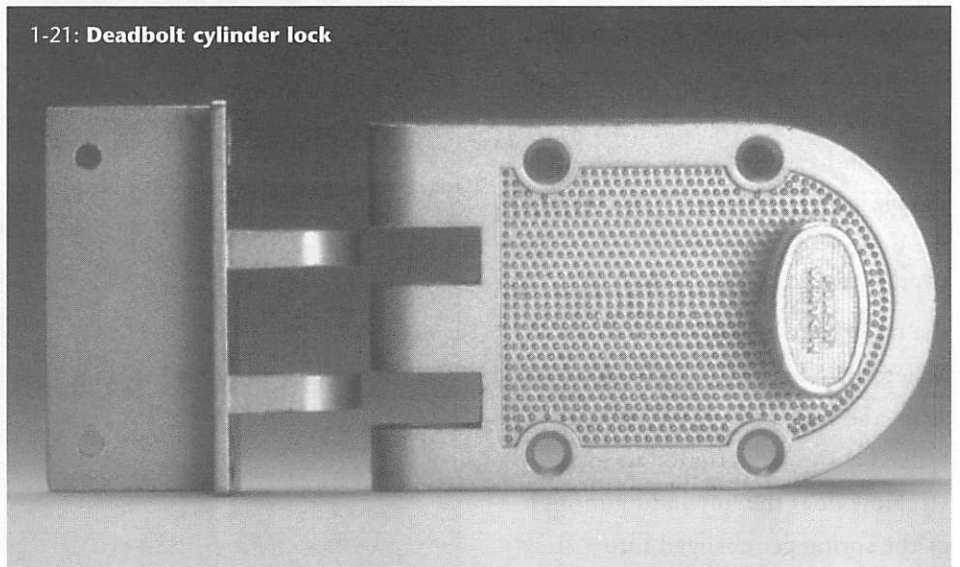

1-22: Egg topper

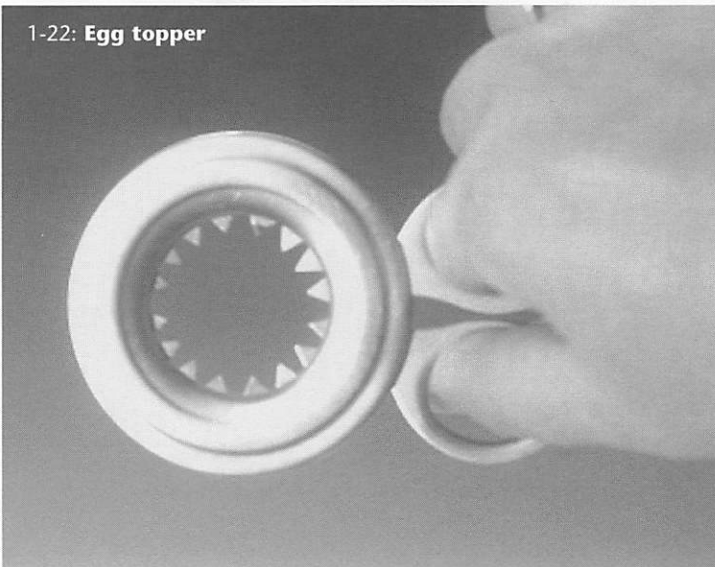

Challenge #2: The Egg Topper

The next example is the egg topper originally shown in the open position in Figure 1-7. This is a device for cracking the shell of a soft-boiled egg, so the top can be removed. Its two handles, when they are squeezed together, force the teeth all around the top of the egg. (See Figure 1-22.) What makes the teeth move toward each other when the handles are squeezed? What makes them return to their concealed positions when the handles are released?

Challenge #3: A Wind-up Toy

The wind-up toy crab shown in Figure 1-11 walks sideways, arms waving and eyes bobbing, when the key in the back (not shown) is wound up and released. It walks by alternating between two positions, which are shown in Figures 1-23 and 1-24, respectively. In Figure 1-23, the crab's legs are retracted and the body is resting on the ground. The arms are out and the eyes are up. As the spring unwinds, the legs come down, the arms go up, and the eyes come down, as shown in Figure 1-24. Then it repeats the same cycle, over and over again. While the legs are resting on the ground, the body shifts slightly to the right. When the body reaches the ground again the next time, it has actually walked about a quarter of an inch.

How does the unwinding motion of the spring get changed into the various motions of the legs, arms and eyes, and how does the body manage to shift sideways while the legs are down? We'll show you the answer to this one, too.

1-23: Wind-up crab with body on the floor

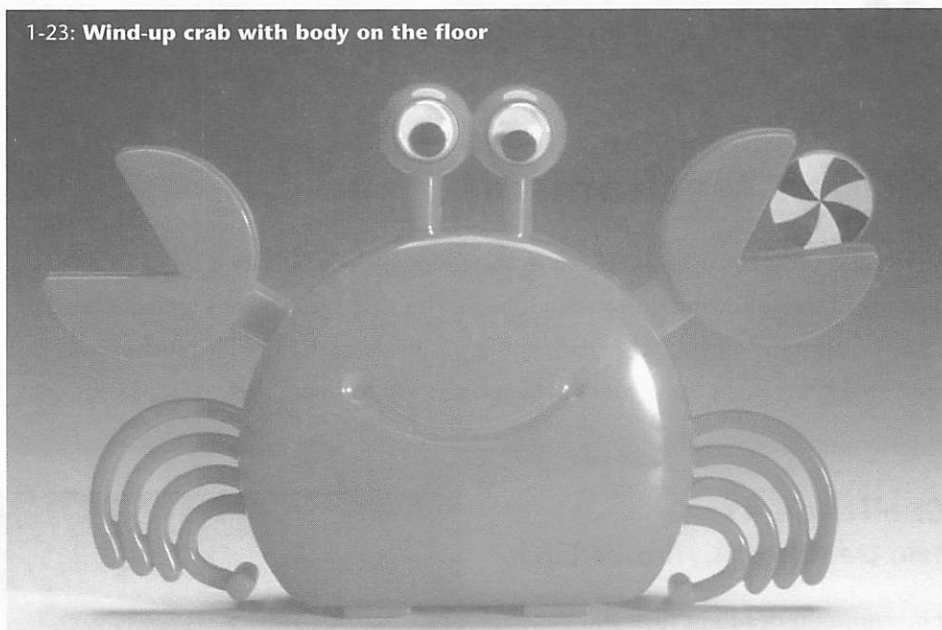

1-24: Wind-up crab with legs on the floor

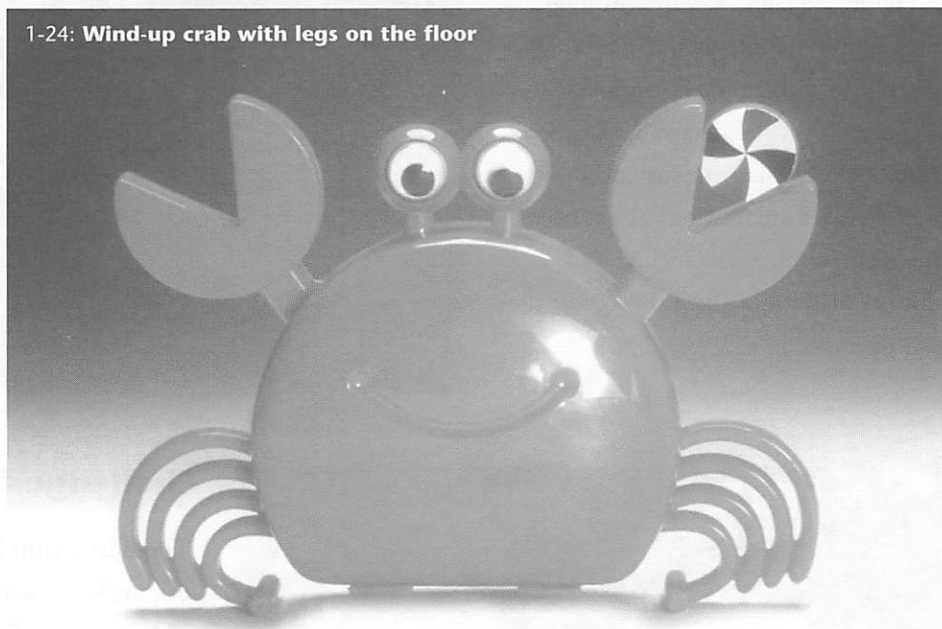

Hidden Mechanisms Revealed: What's Inside

Challenge #1: The Deadbolt Cylinder Lock

The lock can be taken apart by removing a few screws. It can be a little tricky to put back together, however, because one of the springs may fly off as the cover is removed. The mechanism is shown in the open position in Figure 1-25A. The knob or key (not shown) operates the two ears, which

turn in the direction shown by the arrows. As they do so, they push against the movable plate carrying the two bars up and down. To close the lock, you have to turn the knob clockwise (in this view) so the ears turn through the positions shown in Figures 1-25B, C, and D. As the

bottom ear in Figure 1-25A turns to the left, it pushes the plate up, lifting the two bars, which first become visible in Figure 1-25C. When the lock is turned the other way, the opposite ear has the job of pushing the plate down, disengaging the two bars.

1-25A, 1-25B, 1-25C, 1-25D: Deadbolt cylinder lock in four positions starting with "open" (A) and proceeding to "closed" (D).

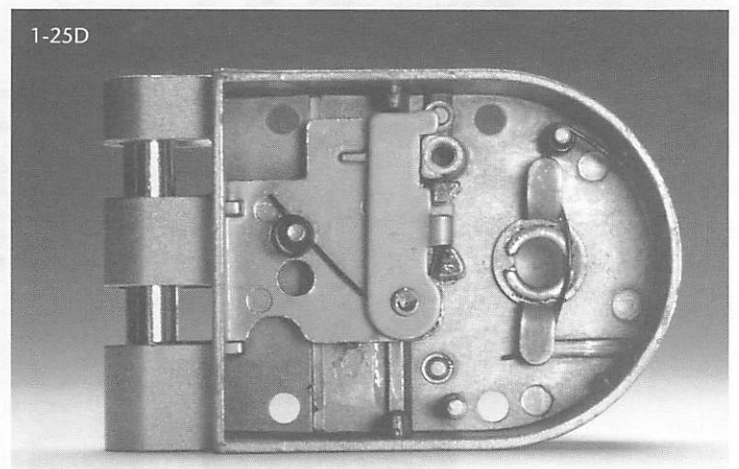
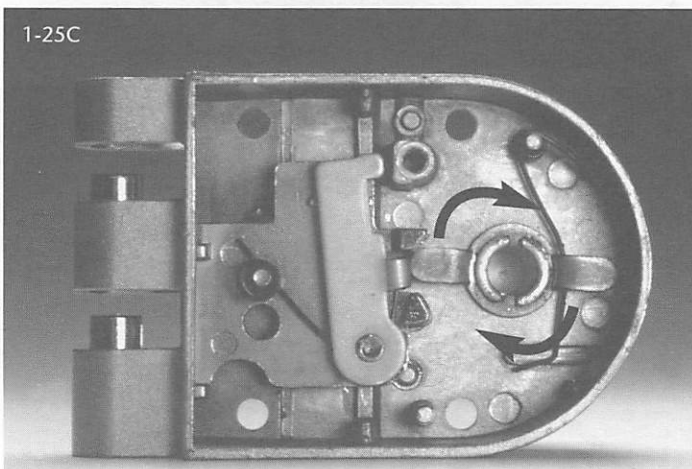
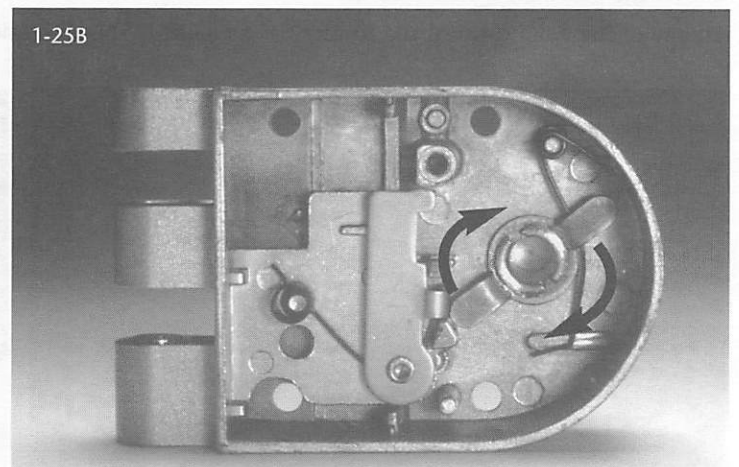
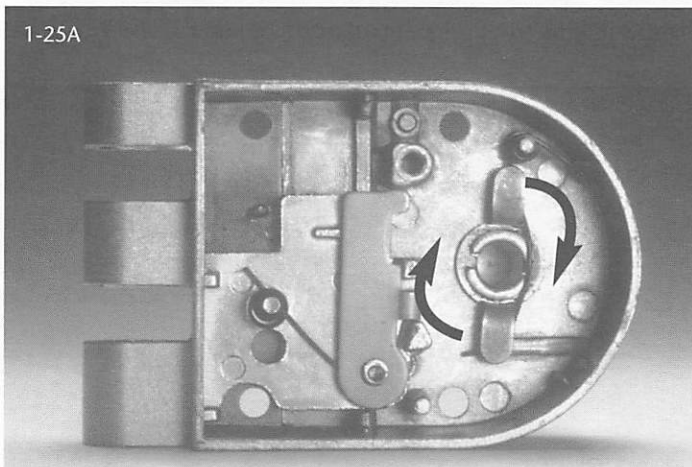

Challenge #2: The Egg Topper

Figure 1-26 shows the inside of the egg topper. The left side has been removed and the right side has its teeth retracted. Each side has two sets of teeth. The pivots are arranged so that moving a handle toward the center forces both sets of teeth inward. (See Figure 1-27.)

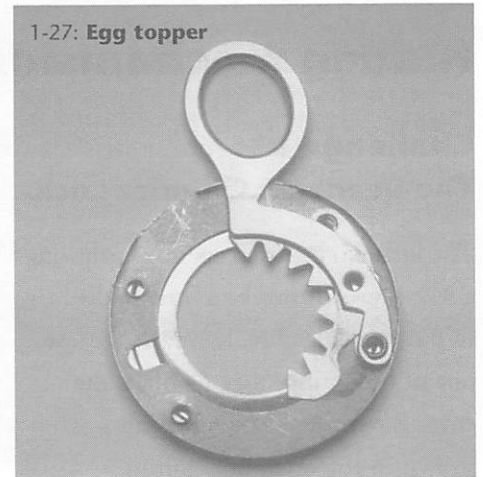
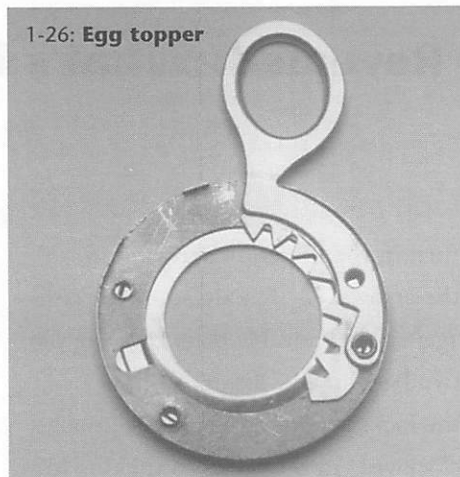

Challenge #3: Wind-up Toy Crab

The inside of the toy is shown in Figure 1-28 in the “body down” position, and in Figure 1-29 in the “legs down” configuration. Figure 1-30 shows the gearbox, which uses the energy of the wound-up spring to turn

the little white wheel with the off-center peg. As the wheel turns, the peg alternately lifts the legs and eyes (Figure 1-28) and lowers them (Figure 1-29) by forcing the frame up and down. In Figure 1-31, the frame has been removed,

revealing how each arm is mounted. As the frame moves the end of the arm, it makes the entire arm rotate around the pivot near the center (marked by arrow). Because of this, when the frame goes up, the arms go down, and vice-versa.

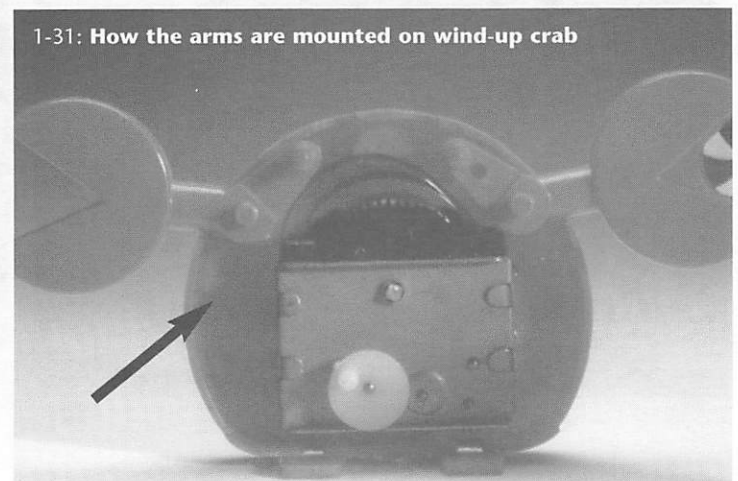
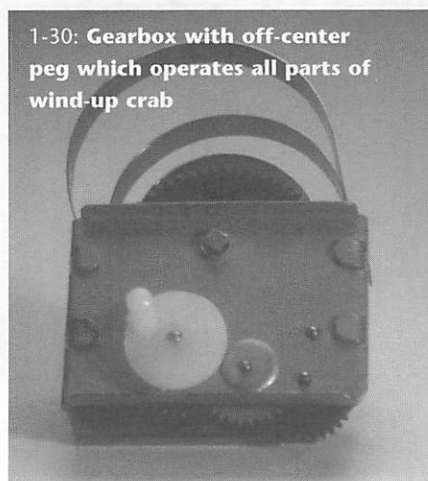
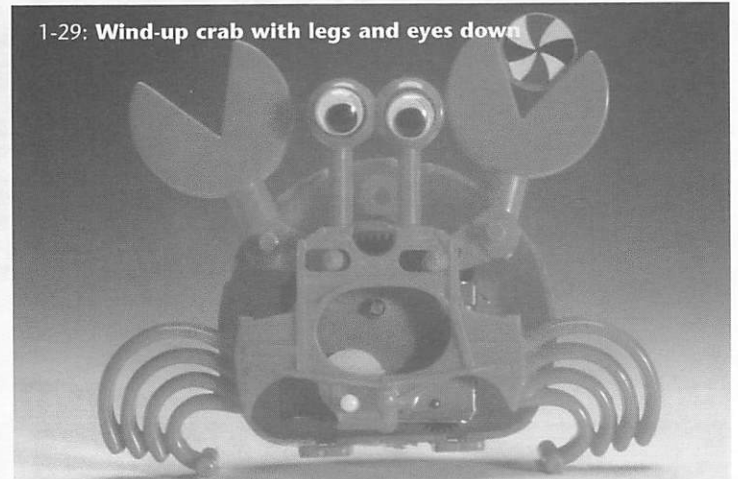
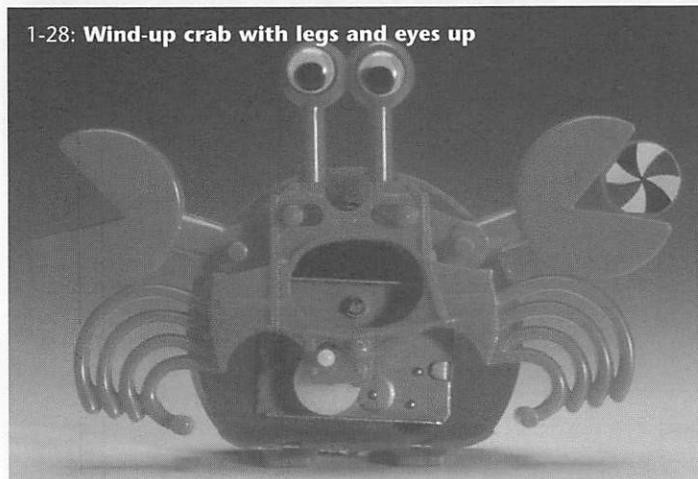

Making Models

A great way to get the “feel” for how a mechanism works is to make a model of it. Modeling is an activity that bridges the gap between analysis and design. In order to make a model of something, you have to analyze it carefully, identifying input and output, and all of the parts in between. In many mechanisms, the shapes of the parts and exact locations of the pivots are critical to its operation. A model that is not done to scale may not work the same way as the original.

Modeling involves many aspects of design. The modeler has to decide what size to make it, what materials to use, and so on. Once you have made the model, you still have to test it to see if it works properly, just as you would with any “from-scratch” design problem. Because there are so many factors to consider, it is likely that you will need to redesign some aspect of your model, and test it again!

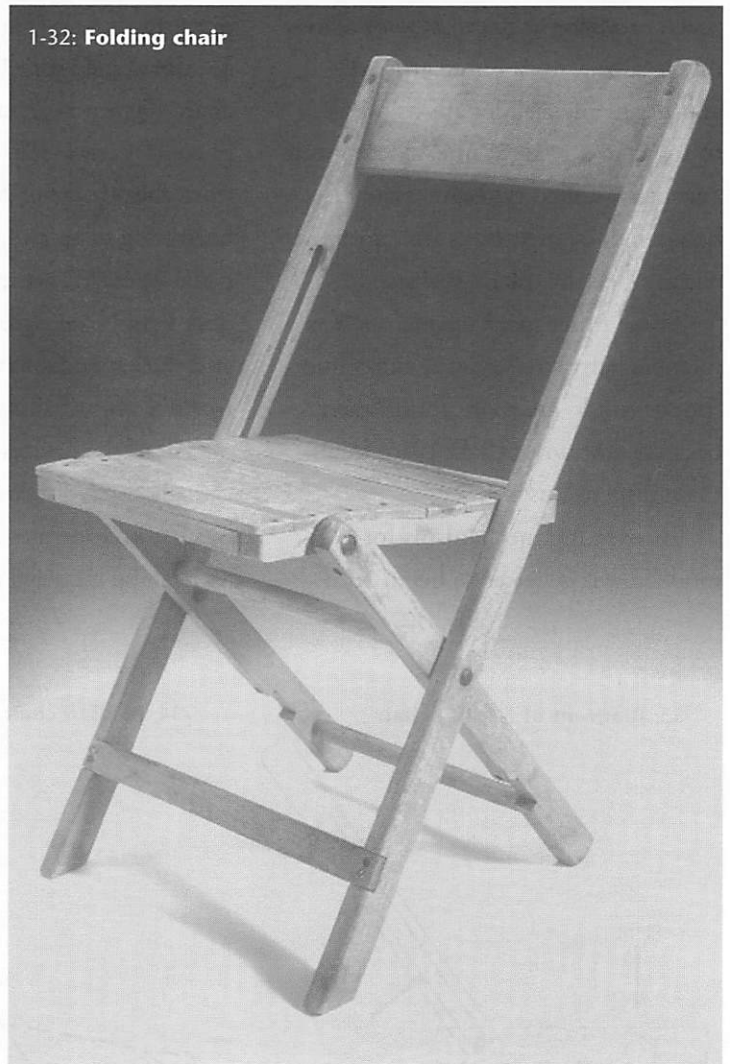

The easiest mechanisms to model are two-dimensional. Two-dimensional linkages consist of three or more links (which are rigid rods) joined by either pivots or sliders or both. A pivot allows one link or arm to rotate around another, while a slider allows a link to move in a straight line. These mechanisms are called two-dimensional because all of their links have to move within the same plane surface.

Some other mechanisms, such as foldable baby strollers and automatic sponge mops, are more complicated because motion can take place in all three dimensions at once.

In selecting mechanisms for modeling, it is better to begin with

the simpler two-dimensional linkages. Some examples of two-dimensional linkages are the eyelash curler (Figures 1-3, 1-13, 1-14), collator (Figure 1-5), pizza tray holder (Figure 1-8), bicycle handbrake (Figure 1-10), folding chair (Figure 1-32) and retaining ring pliers (Figure 1-38). Other examples from the scavenger hunt list at the beginning of this chapter include the pedal-operated wastebasket, adjustable desk lamp, ironing board, drying rack, and the expandable tray sewing box (or tool kit or fishing tackle box).

All of the devices listed above are actually three-dimensional, but the basic mechanism operates in two dimensions and can be modeled on a flat surface.

An example is the folding chair (Figure 1-32), whose mechanism can be modeled using flat pieces of cardboard.

Figure 1-33 shows a two-dimensional model of one side of the chair. It incorporates the entire fold-up mechanism of the actual chair. When some teachers in a workshop were trying to model this folding chair, they had difficulty placing the notch correctly. As a result, they couldn't get the seat to be exactly horizontal in the open position. (See Figure 1-34.) These problems led to several cycles of design and redesign until they finally achieved a model like Figure 1-33.

1-33: Diagram of folding chair

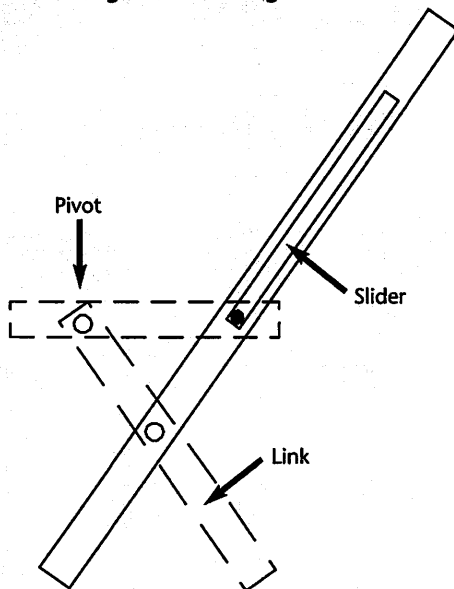

1-34: Folding chair models with notch too high (left) and too low (right)

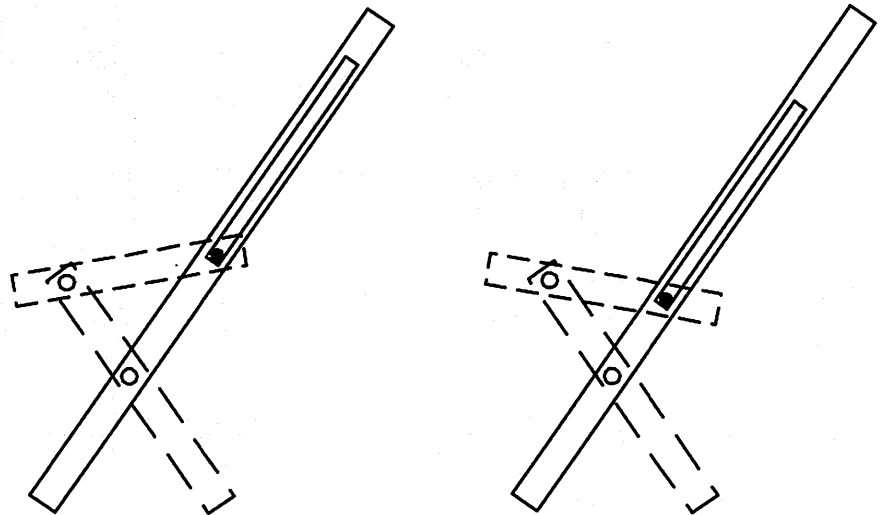

What should the links be made of?

A link is simply a rigid piece, such as one of the rectangles on the folding chair model in Figure 1-33. Links should be made of something that is fairly stiff and strong, not too difficult to cut, and very inexpensive or (better yet) free. Cardboard is the only material we have found that meets all of these criteria.

Figures 1-35 A, B, C, D, and E show four of the most common types of cardboard, all of which are useful for modeling mechanisms. A is “card stock,” used to make index cards, file folders, and other items that don’t need to be very stiff. B and C are made of heavier grades of flat cardboard, and are used to package food and other small items.

D is a thin grade of corrugated, often found in pizza boxes, shoe boxes, and the like. E is a common grade of corrugated cardboard, found in medium-sized cartons. All five types of cardboard can easily be cut with a scissors or punched with a standard hole punch.

As you begin to experiment with these materials, you will notice some major differences among them. A strip of card stock, for example, cannot be pushed too hard from one end, or it will buckle. On the other hand, the thicker corrugated grades are harder to join, because the pivots need to be longer and the rougher surfaces do not slide as easily.

An interesting feature of corrugated cardboard (Figure 1-35E) is that its properties depend on the way it is oriented. Cut a small strip of cardboard as shown in Figure 1-35F. If you push both ends parallel to the corrugations, you will find it much stronger than if you push at right angles to them as in Figure 1-35G.

1-35: Five types of cardboard

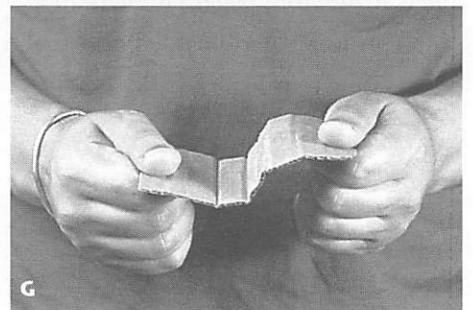
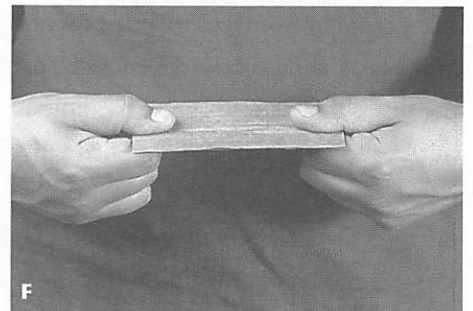
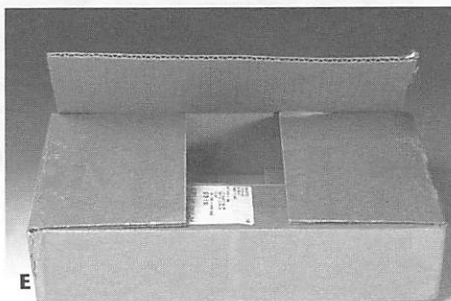
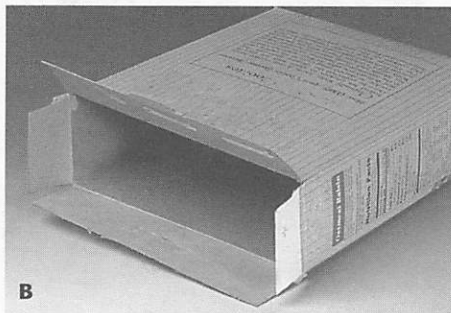
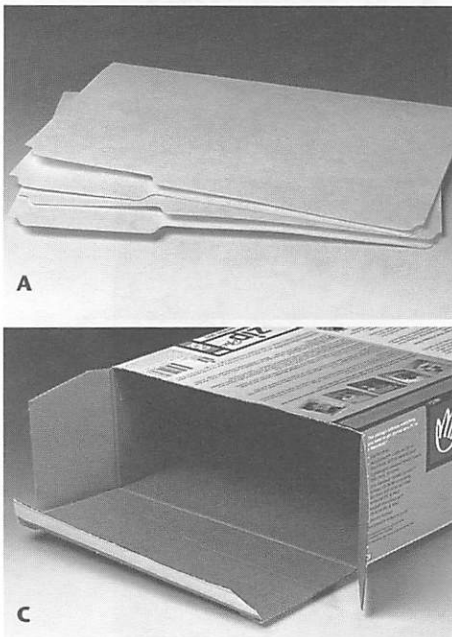

How can you make a pivot, which allows one link to rotate with respect to another?

The open circles on the folding chair model in Figure 1-33 are pivots.

The brass paper fastener (Figure 1-36) is very useful for making a pivot between two links or for attaching a link or guide to a cardboard base.

Begin by using a hole punch to make holes in the two links to be joined. When you open the two tails and flatten them, the heads and tails should prevent the fasteners from slipping out. Their major drawback is that their shafts are flat rather than round, and the links may not be able to move freely around them.

Paper fasteners come in several sizes, ranging from 1/2 to 1 1/2 inches long. They should be large enough so the heads don't slip through the holes, but not so large that the flattened tails interfere with one another when the fasteners are close together. Figure 1-37 shows a model of a retaining ring pliers made from paper fasteners and thin corrugated cardboard. The actual tool is shown in Figure 1-38.

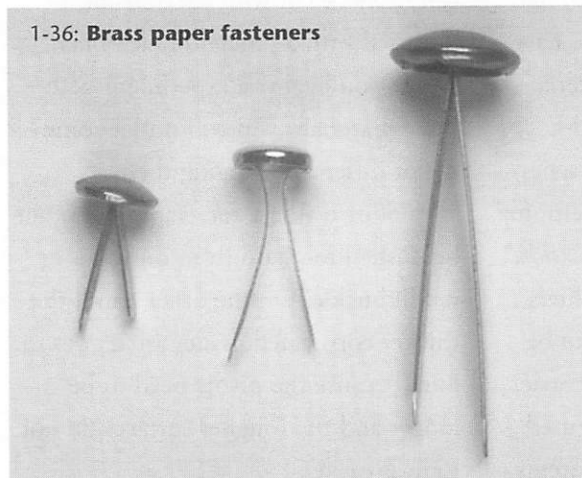

1-36: Brass paper fasteners

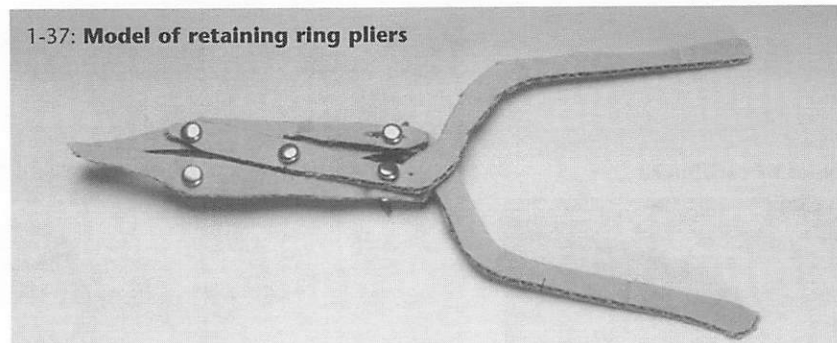

1-37: Model of retaining ring pliers

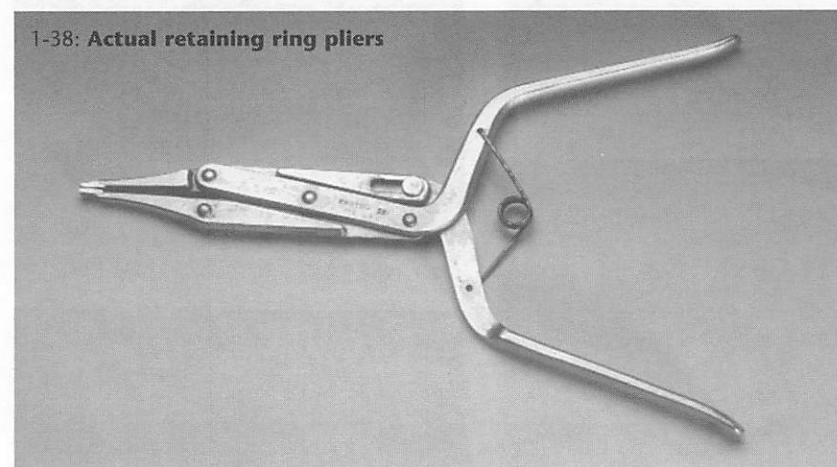

1-38: Actual retaining ring pliers

Another technology we have found for making pivots is the eyelet—the same kind that is used in eyeletting fabric. These are sold in craft stores, along with a special tool for crimping them, which costs about \$10. (See Figure 1-39.) As with paper fasteners, it is necessary to punch holes first, slightly larger than the eyelets; otherwise, the links will not be able to rotate. Unlike paper fasteners, eyelets are permanent—they cannot be removed once they have been installed. Also they do not work with all grades of cardboard—card stock is the best. However, unlike paper fasteners, their shafts are round so the links can move freely, and they look much better than paper fasteners. Some teachers have been very successful with eyelets, but they are more difficult to use than paper fasteners.

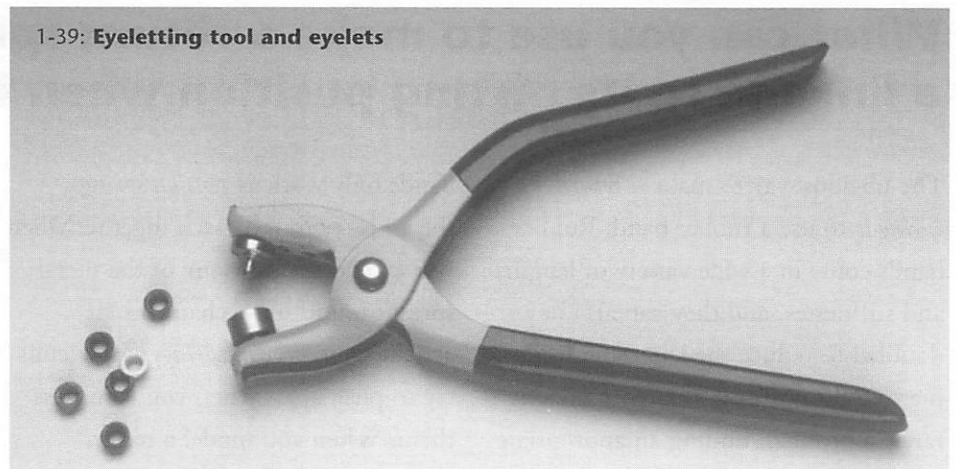

How can you make a sliding joint, which permits a link to travel along a straight line?

The black circular pin-in-slot on the folding chair model in Figure 1-33 is an example of a sliding joint. There are two easy ways to make sliding joints. One involves attaching a guide to the base on either side of a link to force it to follow a straight line, as shown in Figure 1-40. The circles are paper fasteners, which hold the guide in place. A little space should be left

between the sliding link and the guide, so that it can move freely. The other method uses a slot in the base, with paper fasteners holding the front and back of the sliding link together. (See figure 1-41.) The extra piece of cardboard on the back allows the slider to move much more easily, and makes the width of the slot much less critical.

1-40: Sliding joint using a guide

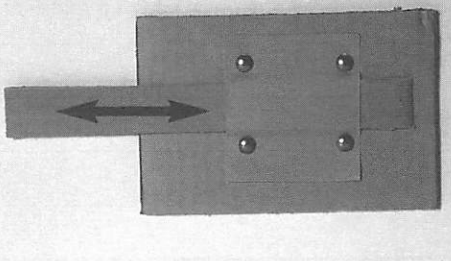

1-41: Sliding joint using a slot and paper fasteners (back and front views)

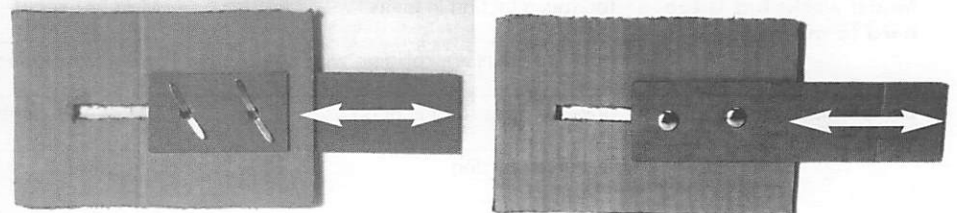

What can you use to make a return spring, which restores a linkage to its resting position when it is released?

The obvious way to make a *return spring* is to use a rubber band. Rubber bands come in a wide variety of lengths and stiffnesses, and they can also be doubled to reduce the length and increase the stiffness; therefore there is rarely a problem finding an appropriate one. One little problem is that rubber

bands only work as *tension springs*: the ends try to pull back together when you extend them. Many of the metal springs found in mechanisms are actually *compression springs* whose ends try to push apart when you compress them. When you model a return spring, you may need to keep this

problem in mind, and mount the rubber band in a different place than the corresponding compression spring. A bigger challenge is finding good places to attach a rubber band. One effective method is to loop it around two paper fasteners.

Model Troubleshooting Guide

A model rarely works perfectly the first time. In a way that's good, because most of what you learn from model-making happens during the process of

troubleshooting and redesign. This troubleshooting guide covers some of the problems commonly encountered in modeling mechanisms.

Table 1-2

TROUBLESHOOTING GUIDE

Symptom	Possible Cause	Remedy
Model can't reach extreme positions	Links are not made to scale	Trace parts directly on cardboard; begin with actual size model
	Joints are not positioned properly	Use chalk or marker to transfer joint positions to model
No return action when released	Return spring missing	Add rubber band
	Return spring too weak	Use stronger rubber band or double it
Inputs or outputs do not move in straight line	Sliding joints are missing	Use guides or slots to constrain motion
Model works but is too hard to move	Too much friction in joints	Make larger holes (pivots) or wider slots or guide openings (sliders)
	Paper fasteners are colliding with one another	Use smaller fasteners, or turn them around
Links buckle or bend when model is operated	Links are not strong enough	Use heavier cardboard for links
	Too much friction	See above
	Parts do not fit properly	Make parts to scale

Mystery Mechanisms: Design Puzzles

1-42: Design Puzzle #1

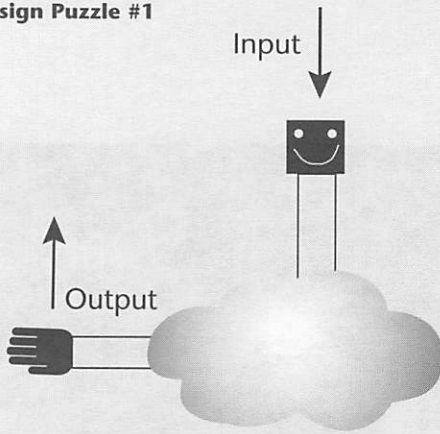

1-43: Design Puzzle #2

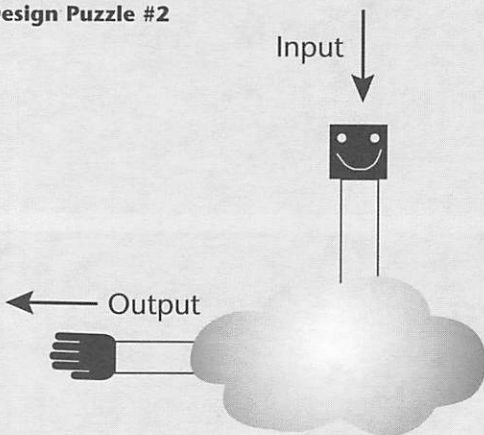

1-44: Design Puzzle #3

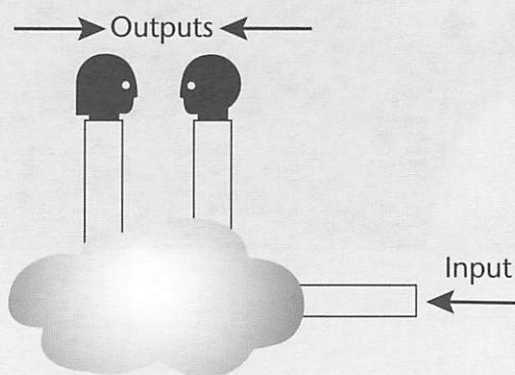

All of these mechanisms can be made using the modeling techniques just described. As you work on the puzzles, look through your mechanism collection for devices that involve similar problems. Each problem is presented by showing the inputs and output(s) only. It is your job to design and test the mechanism that connects the input to the output. The solutions to all three problems are given in the next chapter.

Design Puzzle #1: The arms flap up when the head goes down!

Imagine a doll with a movable head and two movable arms. When you press down on the head, the arms move up. To solve this problem, begin with one side only. The input and output are shown in Figure 1-42.

Design Puzzle #2: The arms shoot out when the head goes down!

This problem is similar to the first, except that instead of moving up, the arms shoot out when the head is depressed. Again, start with one side only. The input and output are shown in Figure 1-43.

Design Puzzle #3: The “kissing couple” problem

Your task here is to make a little toy that has an input on the side, and two outputs on the top. When the input is pushed in, the two outputs come together. We call it “the kissing couple” problem because some children have attached heads on the two output links. They appear to be kissing when the input is operated. The input and output are shown in Figure 1-44.

Casting a Bright Light on Electric Circuits

The Switch Connection

Here is another mystery. Figure 1-45 shows an ordinary flashlight. When you slide the switch forward, as in Figure 1-46, the flashlight comes on. What is going on inside the flashlight when you slide the switch forward? Why does the bulb light when the switch is in the forward, but not the rear, position?

1-45: Flashlight with switch in "OFF" position

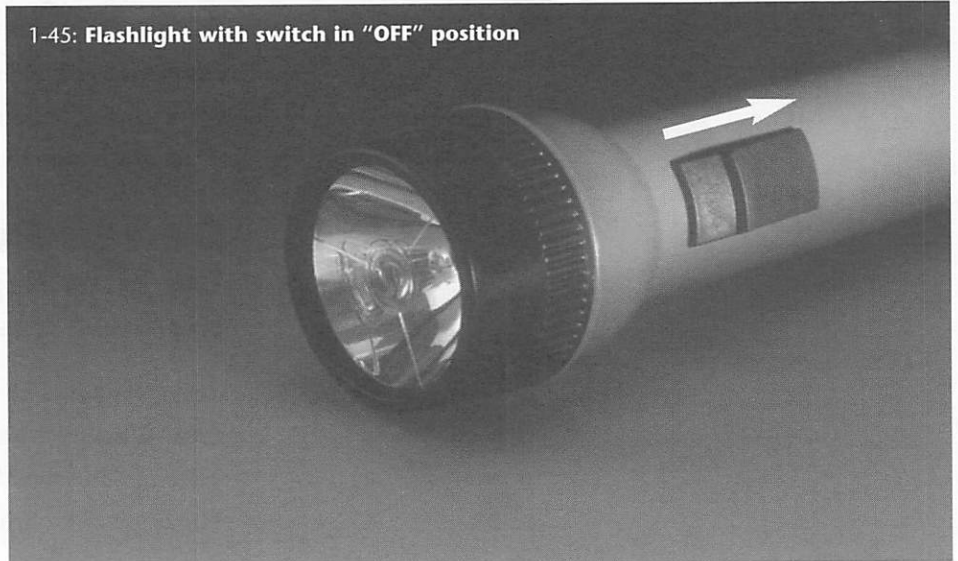

1-46: Same flashlight, turned on

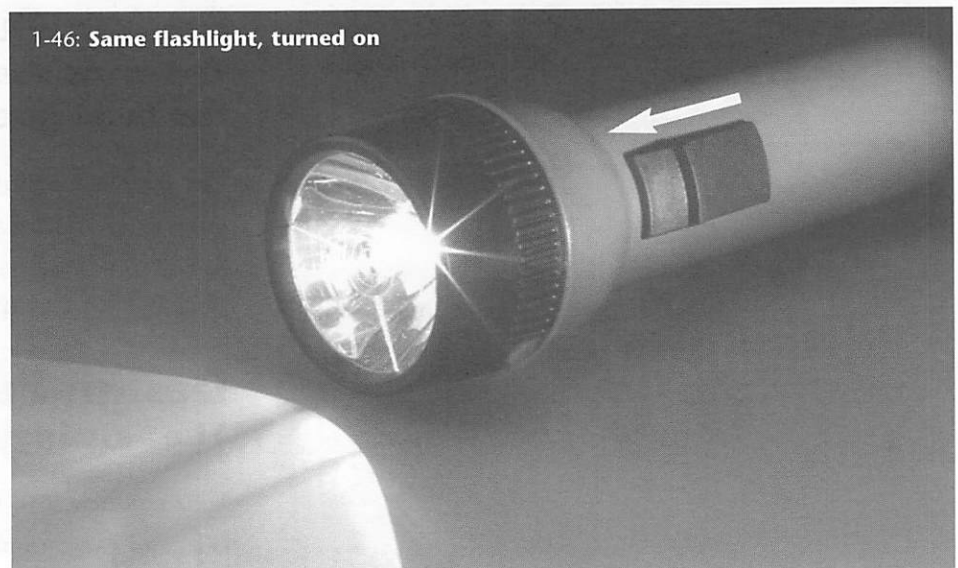

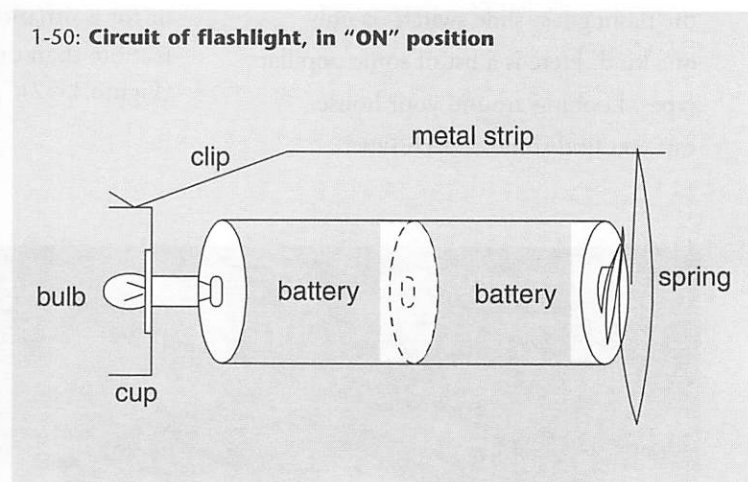
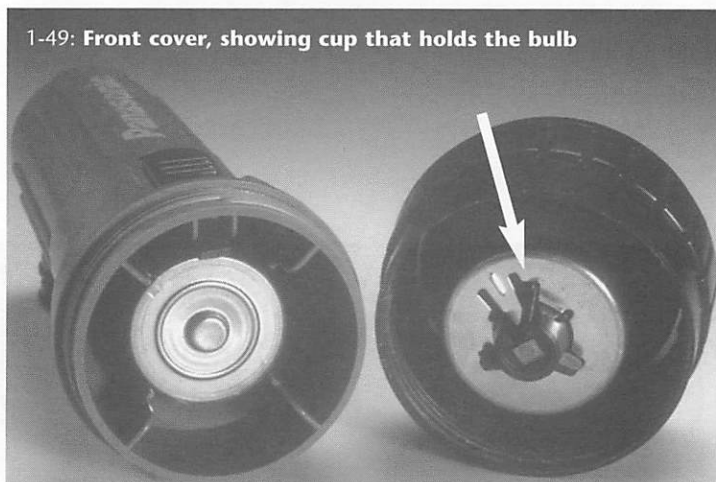
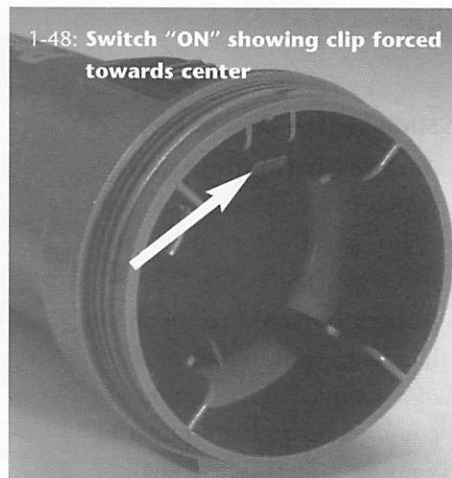
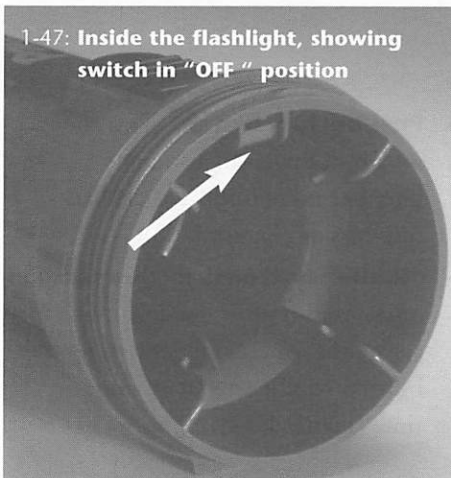

If you remove the cover and the batteries as shown in Figure 1-47, you can see exactly what happens. There is a little copper clip (indicated by arrow) attached by a metal strip to the spring that sits behind the batteries. When the switch is moved forward, it pushes the front of the little clip towards the center (Figure 1-48). This action forces the clip in contact with the metal cup that holds the bulb (Figure 1-49). Now there is a complete *circuit* consisting of the two batteries, bulb, clip, metal strip, and spring (Figure 1-50).

Meanwhile, the tip of the battery is in contact with the end of the bulb, which is its other *terminal*.

This description shows how the switch works mechanically, but it doesn't explain anything at all about how and why electricity makes the bulb light up. We will postpone this discussion to the next chapter. The focus here is on the one mechanical component of the flashlight: the *switch*. Switches of one kind or another control nearly all electrical circuits, and it is worth looking at them closely.

Switch Scavenger Hunt

Most switches have two positions, ON and OFF. The switch that controls the flashlight in Figure 1-45 is an ON/OFF switch that slides back and forth between its two positions. You can leave it permanently in either position; unlike some switches, it does not spring back. There are a variety of common designs of ON/OFF switches, of which the flashlight's "slide switch" is only one kind. Here is a list of some popular types. Looking around your house, can you find some of each type?

- **Slide switch** (Figure 1-45);
- **Rocker (or toggle) switch:** swings in a slight arc, like a rocking chair—most wall switches are of this type (Figure 1-51);
- **Rotary switch:** uses a knob or handle to turn in part or all of a complete circle—often used in conjunction with a dimmer or volume control (see below), or for a situation in which there is more than one ON position (Figure 1-52);
- **Pushbutton switch:** like a slide switch, it travels in a straight line, but in-and-out, rather than side-to-side (Figure 1-53);
- **"Radio" buttons:** another variation of the pushbutton, made famous in car radios, where only one of several buttons can be ON at any one time (Figure 1-54).

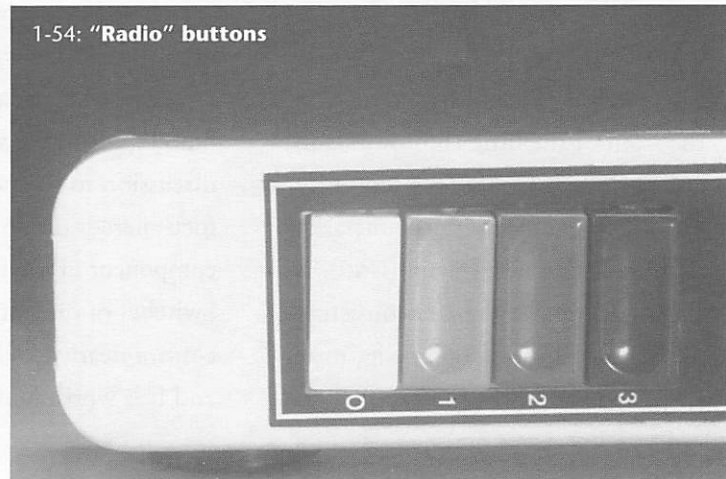
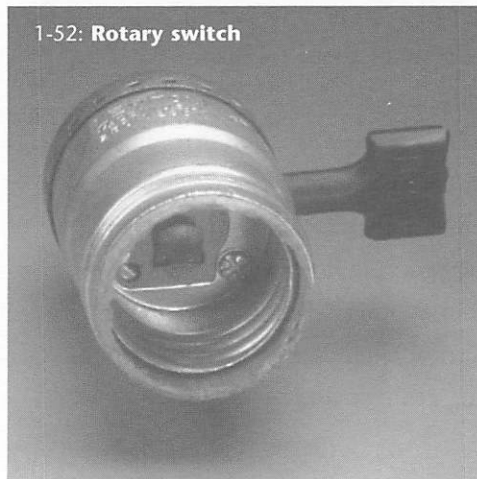
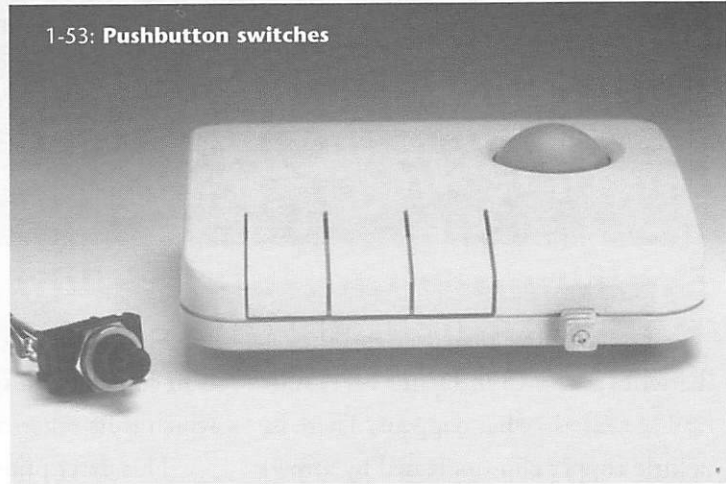
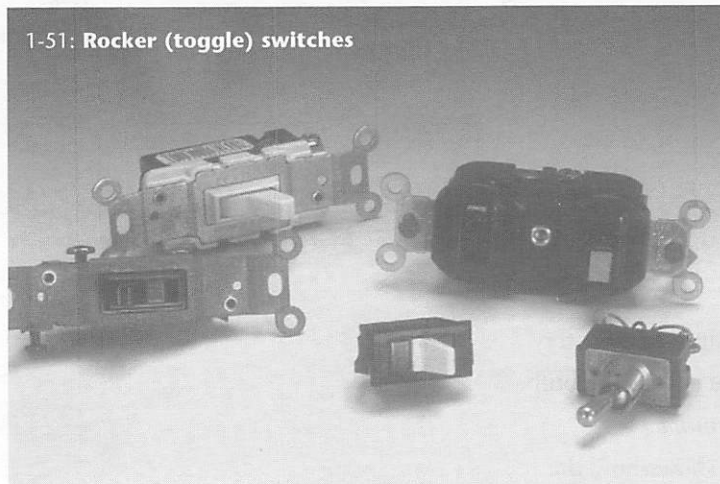

Besides the categories suggested above, what other ways might there be of classifying switches? One question to ask is: What does it control? Each of your switches controls a device that uses electrical energy to produce some kind of output, such as light, heat, sound, or motion. Another way to classify begins with the observation that each switch is also a mechanism. Some of them use levers, while others have sliders; some have return springs, while others don't.

From Switches to Controls

One important category consists of switches that are concealed. Here, the user operates the switch without intending to. Nearly always, these are momentary switches, which are returned by a spring to the OFF position when the device is not in use. For example, when you insert a pencil in an automatic pencil sharpener, the pencil activates a concealed switch. This switch closes a circuit that turns the motor on. The switch returns to its OFF position when the pencil is removed. (See Figure 1-55.) Other examples of concealed switches are:

- the switch under the brake pedal of a car, which operates the brake lights;
- the switch behind a car door that turns on the dome light;
- the switch that turns on the light in the refrigerator; and
- the switch that turns on a telephone when the receiver is lifted.

Try to locate each of these concealed switches and operate them by hand.

Not all switches select between only two positions. Most fans have at least two ON positions, labeled HIGH and LOW. This is also the case with most

hair dryers, clothes dryers, blenders, mixers, and some other appliances that use motors. Some of these devices are controlled by two separate toggle switches, one for ON/OFF, and the other for HIGH/LOW, as in many hair dryers. Other devices use radio buttons for the same purpose (as an example, see the floor fan switches in Figure 1-54). In other cases, a single rotary switch is used to select the setting. (See Figure 1-56.)

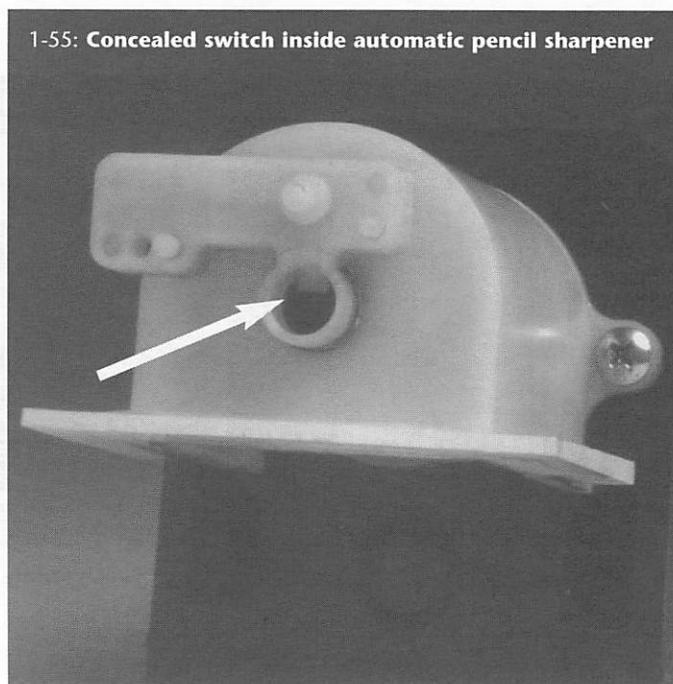

1-55: Concealed switch inside automatic pencil sharpener

Sometimes, a knob or slide mechanism can vary something continuously, rather than select from among a few possibilities. These devices are like switches in that they can turn something on or off, but they are more like faucets in that they can be adjusted to any position between fully on and fully off. (See Figure 1-57.) Anything that can be varied continuously is known as an *analog device*, in contrast with a *digital device*, which has a finite number of discrete settings. A tuning knob on a radio is analog, while the programmable push buttons—referred to earlier as radio buttons—are digital.

A word that includes both the digital “switch” and the analog “faucet” is a *control*. In this section, we will look specifically at electrical controls—those that adjust the flow of electricity, while in the next section, we will expand the discussion to include other kinds of controls. In the next chapter,

“Concepts,” we will define and explain the concept of control more precisely.

The preceding discussion suggests some new categories for the scavenger hunt. How many different examples can you find of each of the following?

- multi-position controls that select from more than one possible ON position
- analog controls, which can be adjusted anywhere from fully ON to fully OFF
- hidden controls, which are operated without the user necessarily knowing about them.

What kinds of mechanisms—rotary, toggle, slide, pushbutton, or momentary—are most frequently used for each kind of control?

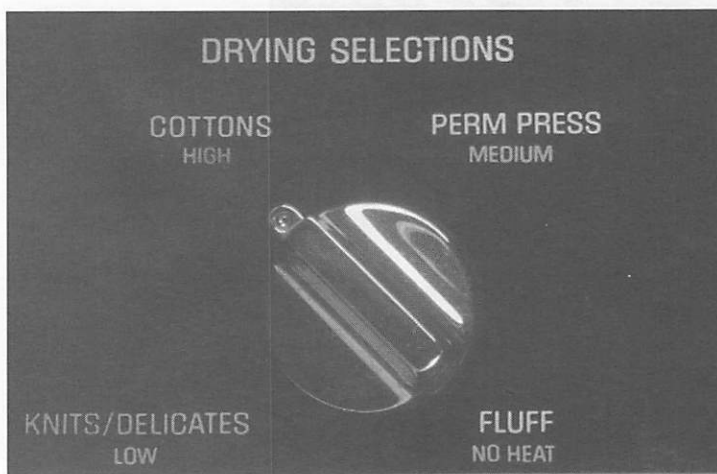

1-56: Rotary multi-position switch

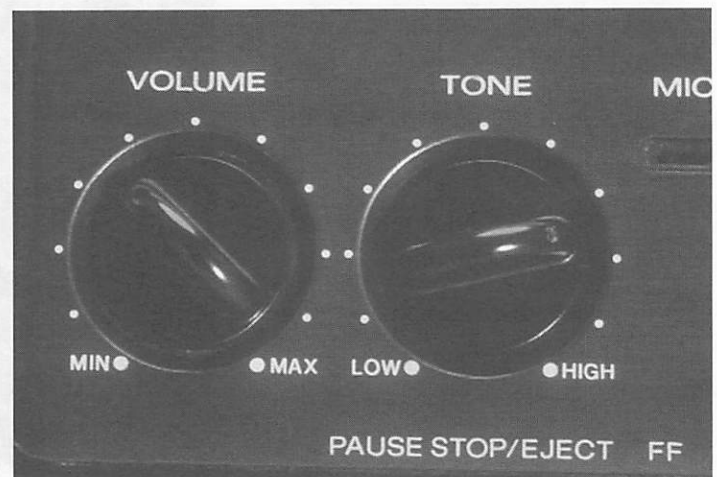

1-57: Continuously variable controls

Electric Circuit Challenges

As with mechanisms, an excellent way to learn about circuits is to model them. We conclude this chapter with a few more challenges, this time involving circuit models. We are presenting these challenges in increasing order of difficulty. Don't worry about what the models look like. The important thing is that they should work like the real thing.

You will need the following materials: at least one battery, at least one bulb, and some wire, preferably insulated. (See Figure 1-58.) If the wire is insulated, you will need a wire cutter/stripper to remove the insulation at the ends, as shown in Figure 1-59. These components are ordinarily supplied with science units on "Batteries and Bulbs." It is helpful, but not absolutely essential, to have bulb holders and battery holders, to make it easier to connect wires to these components. If bulb and battery holders are not available, just use a little tape to secure the stripped end of a piece of wire to the contacts, as shown in Figure 1-60.

You will also need a switch, but if you don't have it, you can always make one. The switch can consist simply of two wires that are touched together for one position and separated for the other. Better yet, you can make a permanent switch using anything made of fairly flexible metal, such as a paper clip, hairpin, or piece of aluminum foil, as shown in Figure 1-61.

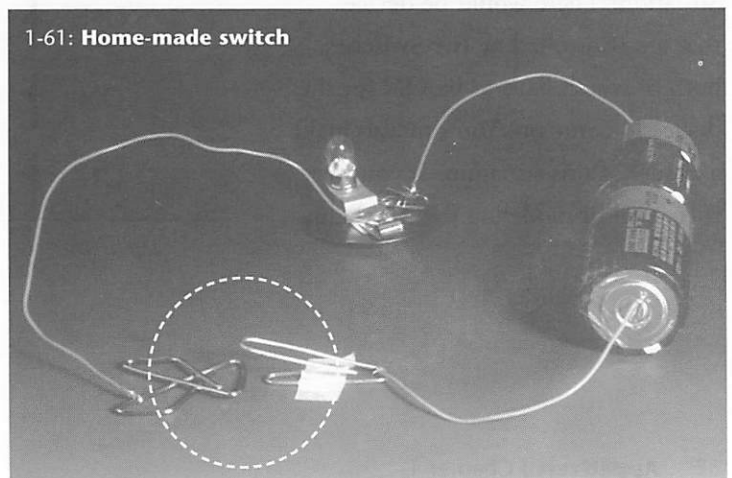
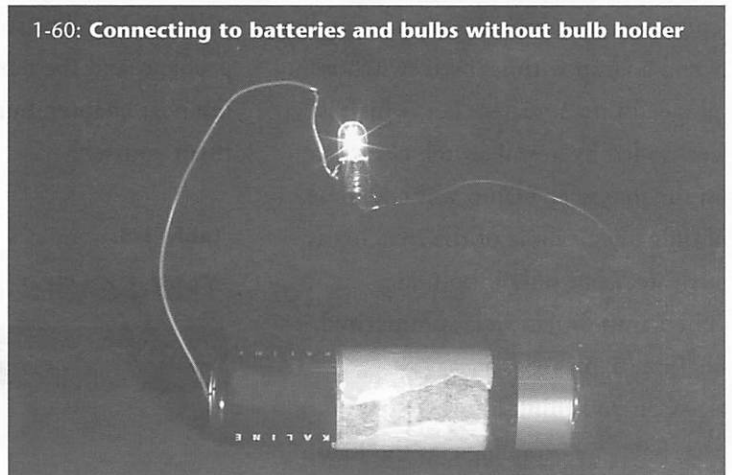
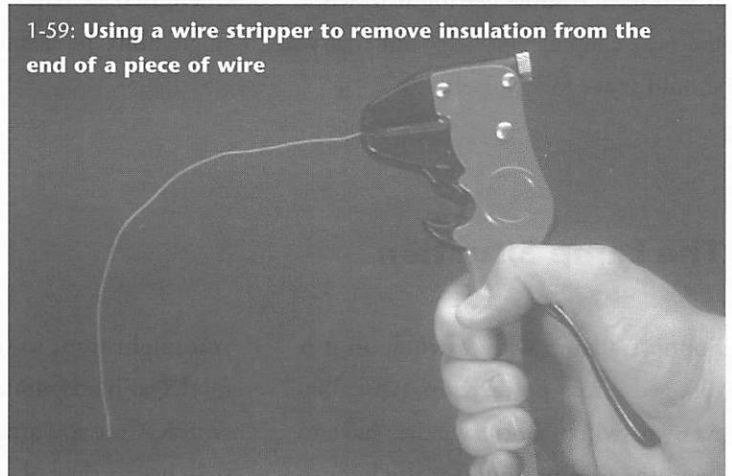
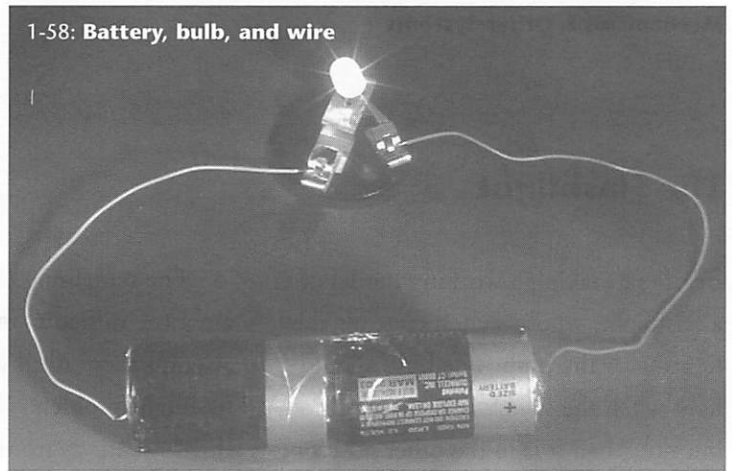

The Flashlight

Begin by making a working model of a flashlight, whose switch controls the lighting of the bulb. The bulb should light when the switch is in one position, but not when it is in the other position. If you have trouble getting it to work, the next chapter will help, but first you should try it for yourself!

The remaining circuit challenges are more difficult, and you should not attempt them until you have solved the flashlight problem. We will describe three situations from everyday life where two switches need to control a single bulb. In each case, the logical

relationships between the switches are different. The questions each time are:

- Can you think of other examples where the same logic applies?
- Can you model this situation using batteries and bulbs?

The Lamp Situation

Suppose a lamp with a switch on it is plugged into a power strip, which has its own switch. Both switches have to be in the ON position for the light to come on. The same description applies when a lamp with its own switch is plugged into a wall socket, which is controlled by a wall switch elsewhere in the room. The lamp will not come on if only one or none of the switches is activated, but only if both are.













The Lamp Situation is summarized in Table 1-3.

Can you think of other systems that have the same logic as the Lamp Situation? These would be devices that are controlled by two switches, both of which have to be ON for the device to come on. You can also make a model of this situation. If you were successful in modeling the flashlight,

you might want to try modifying your model to incorporate an additional switch. Can you arrange the two switches so they obey the logic shown in Table 1-3? The solutions to this problem and the next two are in the next chapter, but first try to do them yourself!

Table 1-3

THE LOGIC OF THE LAMP SITUATION

Switch on Power Strip	Switch on Lamp	Lamp
OFF 	OFF 	OFF 
OFF 	ON 	OFF 
ON 	OFF 	OFF 
ON 	ON 	ON 

The Yard Light Situation













A floodlight is set up to illuminate the back yard of a house. There are two switches that operate the yard light, one inside the house and the other in the yard. Either switch (or both at the same time) will make the yard light come ON. This situation is summarized in Table 1-4.

Notice the differences between Table 1-3 and 1-4. Table 1-3 has only one combination that turns the lamp

on, while Table 1-4 has three. In the Lamp Situation, both switches need to be ON to make the lamp come on, while in the Yard Light Situation, either one, or both, will do the trick. Another example of this situation is a two-door car with a dome light. In this case the switches are concealed. Opening either door, or both, will make the dome light come on. Can you think of other examples?

Table 1-4

THE YARD LIGHT SITUATION

Indoor Switch	Outdoor Switch	Yard Light
OFF 	OFF 	OFF 
OFF 	ON 	ON 
ON 	OFF 	ON 
ON 	ON 	ON 











The Stair Light Situation

The third configuration, the Stair Light Situation, is also fairly common, but considerably more difficult to model. If your house has more than one floor, it is likely that you have a ceiling light at the top of a stairway. Two switches usually control this type of light—one at the top of the stairs and the other at the foot. Either switch can turn the light ON. So far, this sounds exactly like the Yard Light Situation, but there is a difference. Either switch can also turn the light OFF, which is not the case in the Yard Light Situation.

To see how the stair light works, imagine that you are at the top of the stairs. Both switches are in the DOWN

position, and the light is OFF. To see your way down the stairs, you push the top switch UP, turning the light ON. When you reach the bottom, there is no longer any need for the light, so you push the switch at the bottom UP, turning the light OFF. This situation is similar to the Yard Light, in that either switch, alone, will turn the light ON, but different in that activating both of them will turn it OFF again. The Stair Light Situation is summarized in Table 1-5. You can compare Tables 1-4 and 1-5 directly. Note that the Stair Light Situation is identical to the Yard Light situation, except for the case where both switches are ON.

Table 1-5
THE STAIR LIGHT SITUATION

Upstairs Switch	Downstairs Switch	Stair Light
OFF 	OFF 	OFF 
OFF 	ON 	ON 
ON 	OFF 	ON 
ON 	ON 	OFF 