

EnerJeeps (Grades 4-5)

Unit Overview

This unit develops concepts of energy and electricity through design, building and testing of toy electric cars. Students first learn to connect motors to batteries, and then to control these circuits with homemade switches. To understand and troubleshoot their circuits, they develop strategies for making diagrams using standard symbols that everyone in the class can agree on. Next they design, make and test simple cars that can be powered by gravity or pushing, and roll freely enough to overcome friction. Subsequently, they add motors to their cars and develop ways of powering a wheel directly from a motor. They learn and apply troubleshooting techniques, and write troubleshooting guides and instruction manuals for fixing and making their cars. They then explore drive systems, and make another car using a different drive system – powered either by a belt-and-pulley system or a propeller. Finally, they develop circuits for adding lights and horns to their cars, write instruction manuals for making these, and present their cars and writing to an audience.

Table 1: Summary of EnerJeeps Curriculum

Lesson	Title	Summary
1	Turn a Motor on	Experimenting with motors, looking at direction of motion
2	Make a Switch	Creating a switch from paper clips and fasteners
3	Circuit diagrams	Finding standard ways to represent circuits
4	Let's roll	Making a car that will roll down a ramp
5	A Direct-drive car	Creating a battery-powered car.
6	Troubleshooting a Direct-drive car	Getting the battery-powered car to work, writing a troubleshooting guide
7	How to Build a Direct-drive car	Writing an instruction manual for making a battery-powered car
8	Make a Belt-drive or Propeller-drive car	Learning about drive systems, and creating a car with a different drive system
9	Troubleshooting and Redesign of Belt-drive & Propeller-drive Cars	Identifying issues with the new car, addressing them and writing a troubleshooting guide
10	IMP(rove) your Ride: Add a Horn & Lights	Adding lights and horns to the car
11	Gearing up for the Auto Show	Making finishing touches; writing instruction manuals for making improved cars
12	The Auto Show	Presenting the cars to an audience

Physical science & engineering concepts

1. Energy is needed to make physical things happen.
2. Energy can take many forms. Types include energy of sound, light, heat, position and motion; as well as elastic, chemical, magnetic and electric energy.
3. A **battery** stores energy in chemical form. Whenever the battery is part of a complete circuit, some of this energy changes to electric energy.
4. Electric energy can be converted to almost any form. For example, a **motor** changes electric energy to kinetic energy; a **lamp** changes it to light energy, and a **buzzer** or **speaker** changes it to sound energy. You can't see nor hear electric energy at work, until it changes to light or sound.
5. A **circuit** transfers energy from a battery to a lamp, motor, buzzer, speaker or another device that changes electrical energy to another form. Any device of this kind is called a **load**. A battery and a load each has two sides. Each side allows electricity to flow in one direction or the other.
6. A circuit needs at least one **conductor** that allows the electricity to flow from one contact of the battery to one contact of the load, and another conductor for the return path from the other contact of the load back to the other contact of the battery. Otherwise it is not a complete circuit, and the load will not do anything – for example, the light will not come on, or the motor will not turn.
7. Some loads are **polar**: it matters which way you connect them to the battery, which is also polar. A polar load has a (+) side that has to be attached to the (+) side of the battery, and a (–) side that has to be attached to the (–) side of the battery, or it won't work. An example is a Light Emitting Diode (LED). A motor is polar too, but not as obviously: it can be connected either way, but it will turn in opposite directions depending on which way it is connected to the battery.
8. A **control** tells a circuit what to do. The most common kind of control is a **switch**, which is needed to turn a circuit OFF, so it is not constantly ON. A switch works by breaking the flow of electricity from one side of the battery to one side of the load. Switches can be classified according to the type of mechanical action needed to operate them: **push button**, **pull chain**, **rotary**, **slide**, or **toggle**.
9. In order for a motor to drive a car, there needs to be a **drive system** (also called a **propulsion system** or **transmission**) that transmits energy from the motor to at least one wheel.
Examples are:
 - ✦ **Direct-drive**: Motor shaft is attached directly to a wheel;
 - ✦ **Propeller-drive**: Motor turns a propeller, which propels car forward by pushing air backwards; and
 - ✦ **Belt-drive**: Motor turns a pulley, which transmits motion to another pulley and wheel through a flexible belt.

User's Guide to EnerJeeps

The unit is subdivided into 12 lessons. The most basic activities of a lesson can generally be completed in one class period, but additional time is typically needed for writing, further exploration and designing. Within each lesson, there are up to seven sections:

Overview provides a brief statement of the purpose of the lesson.

Materials shows a list of the supplies needed for the lesson, in classroom, group or individual student quantities. A group is assumed to consist of 4 – 6 students.

Procedure offers a basic lesson plan, including questions for discussion and prompts for writing entries in the Science Notebooks.

⚡ Lightning bullets and italics indicate prompts for discussion, instructions for students and design challenges .

Science Notebook entries are boxed.

⚡ Writing prompts have lightning bullets.

Homework appears in some lessons – usually in the form of a scavenger hunt for students to conduct at home.

Outcomes provides a statement of the basic conclusions or generalizations to be developed through the lesson.

Worksheets provide structured alternatives to more open-ended writing in science notebooks. If worksheets are used, they should be taped or stapled into the science notebooks to provide a complete record of the unit.

Troubleshooting offers help to the teacher, pointing out common issues in construction, making things work or understanding how and why they work.

Materials for EnerJeeps

Item	Detail	Qty	Lessons used in
Penguin Race Toy	Alternatives: Dalmation Chase or Track Racer	1	1
CR 2032 Coin batteries		60	10-12
LED, 10 mm.	Green, red & yellow; 40 of each color	120	3, 10-12
Buzzer	Red & black wire leads	30	10-12
AA Batteries		100	all
Motors w/ 2 mm shafts		60	all
Wire strippers		2	all
Reclosable storage bag	2 gallon	30	all
Wheels w/ 4mm. holes	Red, yellow, blue or green (Science Source)	30	5-7
Bushing 2 – 4 mm adapter		60	5-12
Wheels w/ 3 mm. holes	Black (Pitsco)	200	4-12
Wooden barbecue skewers	6 " & 8 " 100 of each	200	4-12
Straws	Box of 100, ¼ in. diam.	2	4-12
Cardstock	250 sheets, assorted colors	1	2-12
Cardboard sheets	8 ½ " x 11 "	6	4
Cardboard rectangles	5 ½ " x 8 ½ "	30	5-12
Foam (LDPE)	4 ¼ " x 5 ½ " (¼ sheet)	60	2, 4-12
	cut into 4 " x 3 " x 2 " blocks	30	8-12
Cardboard strips	11" x 1"	100	2, 5-7
Masking tape	Roll, 1 in. x 60 ft.	10	all
Aluminum foil	roll	1	all
Rubber bands	¼ lb. bag, #64 3.5 x 0.25 in	1	4-12
Paper clips	¼ lb. bag, #30, 2 x 0.125 in.	1	4-12
	Box of 100, 1 ea., small & large	2	2-12
Paper fasteners	Box of 100, 1.5 in. brass plated	2	2-12
Galvanized steel wire	Box of 100, 1 in. brass plated	1	2-12
	100 ft. roll AWG #26	2	2, 3, 5-12
Mini-binder clips		60	4-12
Propellers	5" diam. ; hole drilled out to 2 mm	30	8-12
Plastic spools		30	8-12
Steel washers	½ ", box of 50	2	8-12
Digital multimeter	Kelvin 50 LE	2	all

Craft supplies			
Item	Detail	Qty	Lessons used in
Tissue paper	13" x 20" sheet, assorted colors	6	11-12
Cellophane	5" x 25" roll, assorted colors	2	
Google eyes	Small bagful, assorted sizes	1	
Feathers	Small bagful, assorted shapes & colors	1	
Yarn	24 ft., assorted colors	1	
Felt	9" x 12" sheet, assorted colors	5	
Construction paper	9" x 12" sheet, assorted colors	40	
Foam stickers	Small bagful, assorted shapes & colors	1	
Craft sticks	Assorted colors	30	
Ribbon	Roll	1	
Pipe cleaner	Assorted colors	30	
Cocktail umbrella	Assorted colors, 4" diam.	30	

Lesson 1: Turn a Motor On

Overview

This lesson begins by revisiting the classic Batteries and Bulbs unit, using a motor instead of a bulb. The Penguin Race toy is available to provide models of current, voltage, source and load. First, students try to get the motor to run, and then explore how to reverse its direction. Finally, there is a discussion of switches, leading to a Switch Hunt: a scavenger hunt for switches at home.

Materials

- ✦ AA battery and motor – one of each per student
- ✦ Tape
- ✦ The Penguin Race toy – one per class

Procedure

1. The Penguin Race™ Toy: Lead a brief review of electric circuits. It is likely that students have already had experience with “Batteries and Bulbs” or an equivalent unit. Use chart paper to review what is needed to light a bulb from a battery. Use the Penguin Race Toy to illustrate the concepts: Use the Penguin Race Toy to illustrate the concepts (see Troubleshooting for a full discussion) :

- ✦ the escalator gives the penguins energy;
- ✦ they lose this energy as they travel down the slide;
- ✦ they need the escalator to get energy again, so they can go back up.

Ask students to think about how the Penguin Race Toy is similar to and different from an electric circuit:

- ✦ *In a circuit, what is traveling around?*
- ✦ *In the toy, what is traveling around?*
- ✦ *Why does the racetrack need to be attached to both the top and bottom of the escalator?*
- ✦ *Why does the light bulb need to be attached to both sides of the battery?*

Introduce the concept of a **model**: a simplified version of something that reveals important features of the real thing, without being exactly like the real thing. For example, a doll house is a model of a real house, showing rooms and furniture, but not as big as a real house.

Develop the idea that the Penguin Race toy is a model of an electric circuit.

- ✦ *In a circuit, **current** measures the rate at which electrons are flowing around. In the toy model, what plays the role of the current? What would I have to do to increase or decrease the current?*
- ✦ *In a circuit, **voltage** measures how much energy each electron has, and therefore how much it can do. You can increase the voltage by adding batteries. In the toy model,*

what plays the role of the battery? What would you have to do to increase or decrease the voltage?

2. What is a motor? Ask students:

✎ Where have you seen a motor?

Students are likely to identify motors in cars, but explain that here we are talking about an **electrical motor**. Except for starter motors, most car motors get their energy from gasoline, but an electrical motor need electricity to work. Develop a brainstorming list of electrical motors that students have seen or know about. Here are some common places you can find electric motors:

- ✎ Electric fan
- ✎ Refrigerator
- ✎ Washing machine
- ✎ Dryer
- ✎ Vacuum cleaner
- ✎ Electric pencil sharpener

Then ask:

✎ What does a motor do?

Develop the idea that a motor uses electrical energy to make something rotate. It converts electrical energy to **kinetic energy**, which means “energy of motion.”

3. Turn the motor on: Most students will have studied electricity using batteries, bulbs and wires, but are probably not familiar with motors. Explain that we will be using a battery to operate a motor rather than a bulb. Ask:

✎ What does a motor do?

✎ How will you be able to tell when the motor is running?

Provide time for students to experiment and record their findings on the Worksheet.

Important safety note: Like other batteries, these cannot give you a shock. However, other forms of electricity are extremely dangerous. Under no circumstances should any student attach anything to a wall outlet or to an electrical appliance that is plugged in.

4. Make it turn the opposite way: Review the directions in which something can rotate: **clockwise** (CW) or **counterclockwise** (CCW). Provide students with tape. Each student should attach a little piece of tape to his or her motor, and observe the direction of rotation:

✎ Which way does it go, when viewed from the shaft end: clockwise or counterclockwise?

✎ Which way does it go, when viewed from the opposite end: clockwise or counterclockwise?

✎ What would you have to do to make it go in the reverse direction from each view?

An alternate way to find the direction of a motor is to attach a propeller, and see which way the air flows. Provide time for students to experiment and record their findings on the Worksheet.

5. **Batteries, loads and energy transformation:** Introduce the term **load** for anything that electricity can run. The **input** to a load is electrical energy. The **output** from a load is energy in some other form.

✎ *What form of energy goes into a motor? What form of energy comes out?*

✎ *What form of energy goes into a light bulb? What form of energy comes out?*

5. **Switches:** Gather students for a class meeting. Ask students:

✎ *In the circuits you have made so far, what did you have to do to turn them ON or OFF?*

✎ *When you turn a TV, light or hair dryer ON or OFF, what do you do?*

This discussion should pave the way for the Switch Hunt (see below).

Homework

A Switch Hunt. Provide the Worksheet, Part 2, for students to list switches they can find at home or elsewhere. For each one, they should list where it is located, what it controls, and what you have to do to operate it. For example, a light switch is located on the wall, it controls whether electrical energy will flow to a light fixture, and you operate it by pushing it up (on) or pulling it down (off). Other ways you might operate a switch could be by turning a knob, sliding something, or pushing a button down and holding it.

Outcomes

- ✎ An electric circuit requires a battery (or other source), a load and a path that connects each side of the load to a different side of the battery.
- ✎ A motor converts electrical energy to mechanical or kinetic energy (energy of motion).
- ✎ To reverse the direction of a motor, reverse the way the wires are attached to the battery, for example, attach the red wire to the “—” side of the battery and black wire to “+” terminal instead of *vice versa*.

Name: _____ Date: _____

Lesson 1, Part 1: **Motors**

How I made the motor turn on (draw and write)

How is a motor similar to a light bulb? _____

How are they different? _____

How I made the motor turn in the opposite direction (draw and write):

What would you like to make with a motor? _____

Name: _____ Date: _____

Lesson 1, Part 2: **Switch Hunt**

List the switches you found in the classroom or remember from home.

Where I found it	What it controls	How to operate it (push, pull, turn, slide)

When do you use a switch? _____

What does a switch do? _____

Why does a circuit need a switch? _____

Troubleshooting (for teachers only)

The Penguin Race™ Toy

The toy consists of a bunch of penguins, a slide and a motorized escalator that lifts the penguins to the top of the slide, so they can go back down again. Besides being fascinating to watch, this toy provides an excellent model for understanding how an electric circuit works. The penguins are like the electrons, which account for the flow of electricity in a circuit. The escalator lifts them up to a place where they have enough energy to travel down the slide by gravity. It is like the battery in a circuit, which gives the electrons an “energy kick” that is enough for them to travel on their own through the rest of the circuit. While traveling down the slide, the penguins speed up, but then stop when they hit the bottom. In a circuit, the electrons lose their energy in other ways: they may make a bulb light up, create a sound in a buzzer or make a motor turn.

Two basic circuit concepts are current and voltage. The amount of **current** counts the number of electrons that are flowing. In the toy model of a circuit, you could increase the current by adding penguins. If there were too many penguins to fit in the track, you would have to make it wider to accommodate them. Similarly, a wire may need to be bigger to contain more current. The reason an automotive jumper cable or battery cable is so fat is that it takes a lot of current to start a car.

Voltage is a measure of how much energy kick the battery gives each electron as it passes through. The analogy to the battery in the toy model is the escalator. More voltage would correspond to a taller escalator, which would raise the penguins higher, and therefore give them more energy each time they went through.

The penguins make a **complete circuit**, because they have to return to the escalator on each go round to get another energy boost. Similarly, the electrons in a circuit have to return to the battery to get the boost they will need to keep lighting the LED or sounding the buzzer. An analogy is often made between electric current and the flow of water, but this can be misleading, because in most water systems, we don't see the return flow. For example, when you turn on a faucet, you see the water go down the drain, but it's hard to visualize the entire water cycle that brings it back. The penguin toy makes it easier to understand an electric circuit, because it's obvious that the penguins have to get back to the beginning of the escalator to get the energy they'll need to go down the slide again.

Turning on a motor

One wire from the motor has to touch the (+) side of the battery, and the other wire has to touch the (—) side. It doesn't matter which wire is touching which terminal – the motor should come on either way (see next paragraph).

Reversing the connections between the motor and the battery

When you reverse the way the motor is attached to the battery (red to “—“ instead of red to “+”), the motor will turn in the opposite direction. It can be hard to see which way the motor is turning, so it is helpful to add a little piece of tape (or better yet, a feather) to the shaft. The direction it is rotating – clockwise or counterclockwise – should be apparent from the watching closely as it just begins to turn. Whether it is going clockwise or counterclockwise depends on

your point of view. Clockwise viewed from one end is counterclockwise viewed from the other end.

If there is too much insulation on the wires

The wires from the motor might have too much plastic insulation on them, making it hard to get a good electrical connection to the battery. Use a wire stripper to remove extra insulation

Removing a bushing from a motor shaft

The bushing fits tightly on the shaft and is too small to provide a good grip. To remove a bushing, close a wire stripper around the shaft, and use it to pry the bushing off.

Making permanent connections to an AA battery

Students may want to wire their motors to batteries and let them run for a while, without continuing to hold them. Here is a method for attaching wires from a motor (or other wires) to a battery so that will hold them indefinitely.

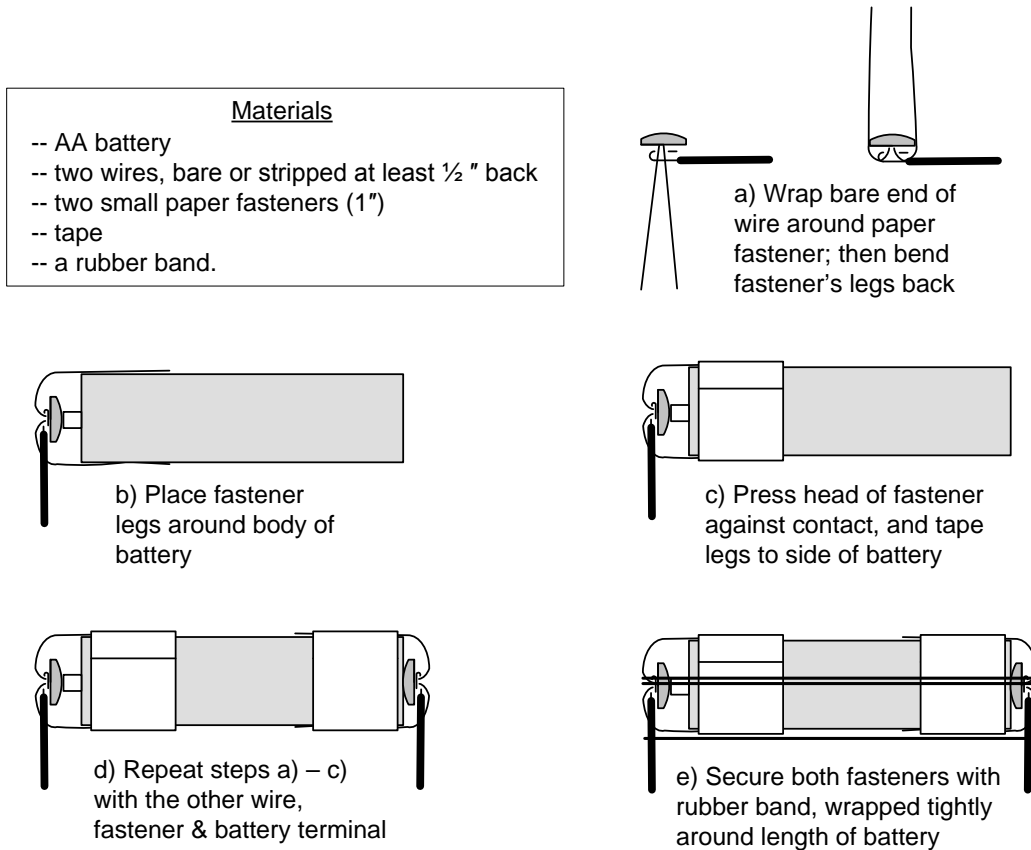

Testing battery connections

The easiest way to see if battery connections are good is to use a **digital multimeter**. See the Appendix, Part 4.

If the battery connections are good and nothing seems to work

1. Make sure the wires connecting to the battery are not touching each other. This would cause a short circuit and nothing would work.

2. Make sure each wire from the motor is touching only one of the two wires from the battery, and that the connection is reliable (see Lesson 3 Troubleshooting: Making good connections between wires).
3. If the motor still doesn't work, the only possible problems are a bad battery or a bad motor. It is more common to find a bad battery. Two ways to find out if a battery is bad are:
 - ↳ Try another battery; or
 - ↳ Test the battery using a **digital multimeter**; see the Appendix, Part 3.

Lesson 2: Make a Switch

Overview

This lesson begins with a review of the Switch Hunt – the scavenger hunt for switches at home. Students discuss the reasons for including a switch in a circuit, rather than turning it on by touching wires together. They then design and create as many types of switches as they can, and use them to control motors. Students look for electrical switches and categorize them according to what they control, and the action needed to operate them. Basic categories are push button, slide, toggle and rotary switches.

Materials

- ✎ AA batteries, motors (as in Lesson 1)
- ✎ Cardboard, paper clips, paper fasteners, aluminum foil, scissors, tape, cardboard, wire (for making switches)

Procedure

1. Switch hunt: Gather students for a class meeting. Review the results of the Switch Hunt students have done for homework. Then provide the worksheet for them to list switches they have found at home or can find in the classroom. For each one, they should list where it is located, what it controls, and what you have to do to operate it. For example, a light switch is located on the wall, it controls whether electrical energy will flow to a light fixture, and you operate it by pushing it up (ON) or pulling it down (OFF). Other ways you might operate a switch could be by turning a knob, sliding something, pulling a string or chain or pushing a button down and holding it. Ask students:

✎ *What is a switch?*

✎ *Where can you find one?*

✎ *What is the advantage of having a switch over touching two wires together?*

Without a switch, a circuit would be ON all the time. Develop the idea that you can use a switch to stop the flow of electricity. This will turn things OFF whenever you don't want them to be ON.

2. What does a switch do? A switch stops the flow of electricity to a load when it is OFF. It allows electricity to flow through the load when it is ON. This means the switch must be placed in a circuit in such a way that all the electricity that flows through the load must also flow through the switch. On a drawing of a circuit with a battery and LED, ask:

✎ *Where could you place a switch in this circuit so it can turn the motor off?*

3. Make a switch: Explain that we'll next be making our own switches. Then ask:

✎ *What kind of parts does a switch need to have?*

Help students see that a switch needs to have two places, metal **contacts** where it connects to a circuit. The switch also has a conductor that can be moved to touch the two contacts and allow current to flow between them. The switch is then ON, and the circuit is **closed**. This conductor can also be moved so it doesn't touch both contacts. Then there

is no way for the current to flow from one contact to the other, the switch is OFF, and the circuit is **open**. No current will flow in the circuit.

Then engage students in thinking what they could use to make a switch:

- ✎ *What kinds of stuff do we have here that you could use to make your own switch?*
- ✎ *What kind of action would you want to take to turn your switch ON or OFF?*
- ✎ *What ideas do you have for making your switch?*

Provide materials and time for students to make and test their own switches. If necessary, provide sample homemade switches (see also [Troubleshooting](#)).

4. Add your switch to a circuit: In order for a switch to work, it has to be in one position for the light or buzzer to be ON, and in another position for the light or buzzer to be OFF. The next challenge is:

- ✎ *Put your switch inside a circuit so it controls the light or buzzer.*

Students should use the Worksheet to draw what they have made, and record the results of testing their switches.

5. Sorting switches by action needed to operate them: After students have made switches and gotten them to work, gather the class to think about types of switches, according to the action you have to take to operate them. Discuss the most common types:

- ✎ *To operate a **rotary** switch, you have to turn something, usually a knob. Switches with multiple ON positions are often of this type. For example, the speed control switch on a fan is usually a rotary switch.*
- ✎ *To use a **toggle** switch, you push a lever up or pull it down, and after you move it, it stays there. Most wall light switches are toggle switches.*
- ✎ *A **pushbutton** switch is one that you have to hold down to keep it ON. A computer mouse, keyboard and cell phone all use pushbutton switches.*
- ✎ *A **slide** switch is operated by pushing a tab back and forth. The ON/OFF switch on the Penguin Race Toy is an example of a slide switch.*

Ask students what kind of switch they have made.

- ✎ *How would you make one of the other types?*

Outcomes

- ✎ A switch is a reliable way to control a circuit. Touching wires together is not reliable, and could even be dangerous.
- ✎ A switch can be made from common materials. It requires two metal contacts where it is connected in the circuit. It also requires a conductor that can touch both contacts to turn the circuit ON and a way the conductor can be moved so it doesn't touch both contacts, which will turn the circuit OFF.
- ✎ Switches can be operated by sliding, turning, pushing, pulling, or holding something down temporarily.

Name: _____ Date: _____

Lesson 2: Make a Switch

How I made my switch (draw and write):

How I added my switch to a circuit (draw and write):

How I could tell if my switch was working : _____

Troubleshooting (for teachers only)

What is a switch?

A switch requires a little bit of force and motion to turn ON or OFF the flow of electrical current. Students may wonder if other kinds of flow should be included. For example, a water faucet, toilet handle, drain plug, stove control knob, mouse trap trigger and the umbrella release button are all like switches, in that they interrupt or allow the flow of energy. However, each of these examples controls the flow of mechanical rather than electrical energy. A water faucet, toilet handle and drain plug allow water to flow or prevent it from flowing. The stove knob does the same for the flow of gas, and the umbrella release and mouse trap trigger each controls the motion of a much larger mechanism. Should these be considered switches?

The word “switch” seems more meaningful if it is restricted to something that controls the flow of electricity. A better word that describes all the devices mentioned above, and includes switches as well, is **control**. A switch is a control that affects the flow of electrical energy; all the others control mechanical energy flows, such as the flow of water, gas or part of a mechanism.

Conductors and insulators

Some materials allow electricity to flow, while others don't. Those that do allow flow are called **conductors** and those that don't are **insulators**. All metals are conductors, and nearly all other materials are insulators.

What a switch needs

The basic requirements of a switch are two contacts, a way of moving one of them so the contact can be either touching (ON) or not touching (OFF), and a connection to each contact that puts the switch inside the loop of the circuit. Both contacts and the connections to them have to be made of conductors, or current won't flow through them. The switch has to interrupt the circuit when it is OFF, and connect the battery to the load (LED or buzzer) when it is ON. When the switch interrupts the circuit, the circuit is **open** and no current can flow. When the switch connects the circuit, it is **closed**, allowing current to flow.

Testing a switch

Testing a switch is easy: the light or buzzer should operate when the switch is in the ON position, but not when it is in the OFF position. . Using a **digital multimeter**, you can test a switch without having a battery or LED connected. To find out how, see the Appendix, Part 7.

Making good connections between wires

It can be difficult to make reliable connections between wires, especially when they are different sizes. Here is a method that works pretty well:

- a) Lay the two bare wires next to each other, then twist them together.
- b) Cut a piece of aluminum foil about 1" x 2". Wrap it around the two wires.
- c) Fold the wires in half so they can't pull out of the aluminum foil.

Ideas for making different kinds of switches

Each of these switches uses the heads of two paper fasteners as contacts. These fasteners should be pushed through a base made of cardstock or cardboard, with both heads up. Attach the wires from the circuit to the tails of these fasteners underneath the base to connect the switch to the rest of the circuit. The switches differ in the mechanisms used to join and separate the two paper fastener heads, and thereby turn the circuit ON and OFF.

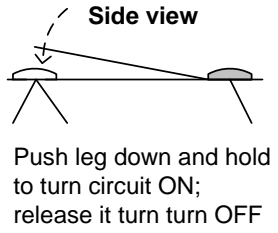
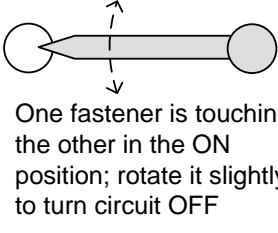
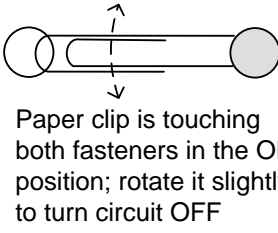
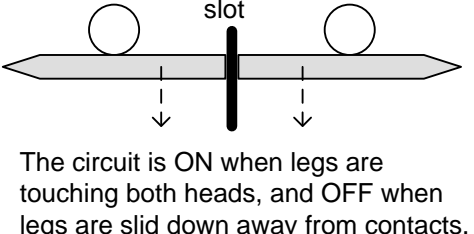
Type	Materials	How to make it
Push-button	Two paper fasteners	<p>Attach the fasteners so that the leg of one can be pushed down to touch the head of the other, and will spring back up when released.</p> 
Rotary	Two paper fasteners	<p>Mount the fasteners so one leg of one is on the same side as the head of the other. Turn the circuit ON by rotating the leg so it touches the head, and turn it OFF by rotating it so they don't touch.</p> 
	Two paper fasteners and a paper clip	<p>Mount the fasteners on cardstock so all the legs are pointing down. Capture a paper clip under the head of one of the fasteners. Turn the paper clip so it touches the other fastener to turn the switch ON; turn it away to turn it OFF.</p> 
Slide	Three paper fasteners	<p>Cut a slot for one paper fastener, and poke holes for the other two. Mount two paper fasteners through the holes with heads up, and mount the third through the slot with both legs up. The legs turn the circuit ON by touching the two heads, and OFF by sliding away from them.</p> 

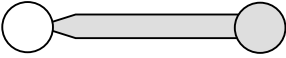
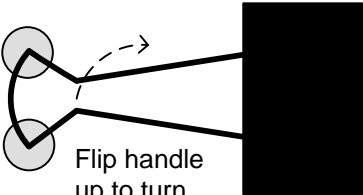
Type	Materials	How to make it
Toggle	Two paper fasteners	<p data-bbox="475 264 946 510">Mount the heads of the fasteners so one leg of one is on the same side as the head of the other. Create a switch that is ON when this leg is captured under the head of the other fastener, and OFF when it is released.</p>  <p data-bbox="1000 327 1260 447">Leg of one fastener is captured in the ON position; release it to turn the circuit OFF</p>
	Bulldog clip and two paper fasteners	<p data-bbox="475 537 963 667">Use the snap action of the bulldog clip to touch and release it from the paper fasteners, and turn the circuit ON and OFF.</p>  <p data-bbox="1057 678 1187 768">Flip handle up to turn circuit OFF</p>

Troubleshooting circuits with switches

The diagram below show a simple circuit with a battery, a motor and a push button switch; and three connections between them, labeled A, B and C.

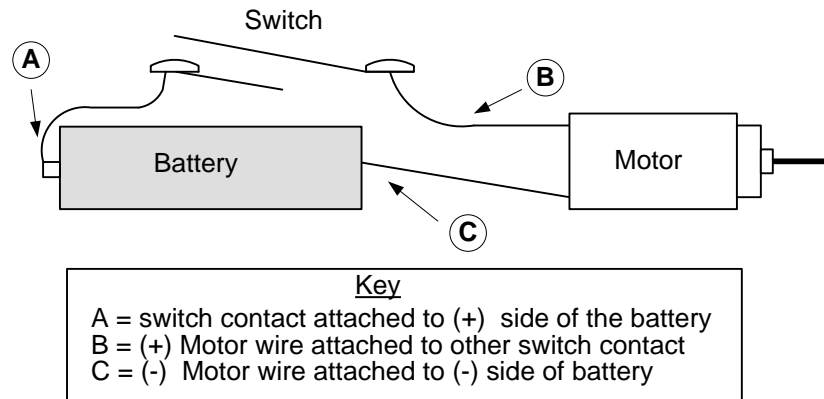

If the circuit is attached as shown in the diagram, and the motor doesn't turn on when the switch is closed, there are five possible **causes** for the trouble. The table below shows how to **test** for each one, and how to **fix** it:

Cause	Test	Fix
Battery or motor is bad	Attach motor directly to battery; if motor still won't turn on, either motor or battery is bad. You can also use the digital multimeter (see the Appendix, Part 3).	Try a new battery. If motor now comes on, old battery was bad. If motor still doesn't turn on, replace motor.
Bad connection at A, B or C	Squeeze each connection in turn. If switch now operates motor, the connection you were squeezing was bad. You can also use the digital multimeter (see the Appendix, Part 4).	Re-do connection, making sure metal is touching metal.

Short circuits

A "short circuit" is a conductor that connects two points that do not appear to be connected, and should not be. There are two common types of short circuits. The most serious type involves a switch that is connected across the battery, as in the drawing below, left. The two dashed lines show the wires that are reversed, compared with the correct circuit, which is shown further down for comparison. This looks similar to the circuit shown above, and it even appears to work, but it has a basic flaw!

SAFETY NOTE: A short circuit across a battery can result in wires getting hot, and potentially causing a minor burn. If anything in a circuit gets warm or hot, disconnect it from the battery immediately. Find the short circuit, and remove it before reconnecting to the battery.

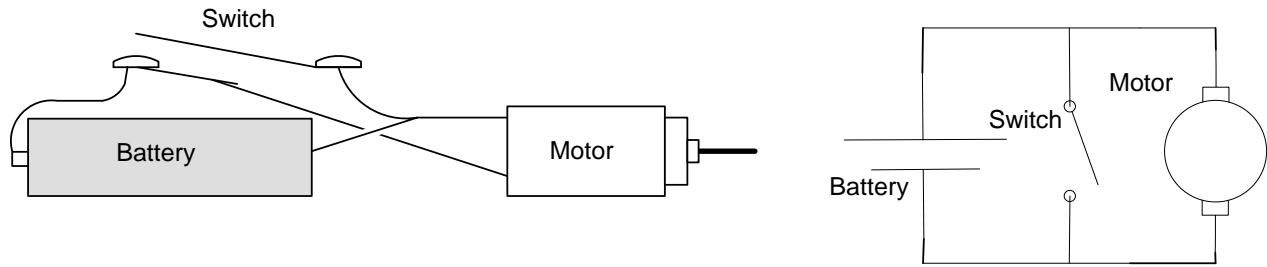

Switch short circuits battery when closed

The switch appears to control the MOTOR, because pushing it down will turn the MOTOR off, and releasing it will turn the MOTOR ON. However, this is the reverse of the way the switch should work. The problem is that the switch is actually ON when the MOTOR goes off, and vice versa. The diagram on the right uses symbols to show the problem more clearly. Lesson 3 develops electrical symbols and diagrams.

When the switch is closed, current flows from one side of the battery to the other with nothing in between. The current bypasses the MOTOR completely, because the current follows the path of least resistance. When the switch is open, it allows the battery to supply the MOTOR normally. If the switch is left closed for very long, the battery will first get warm and then soon go dead.

For comparison, the drawing and diagram below show the circuit that operates correctly.

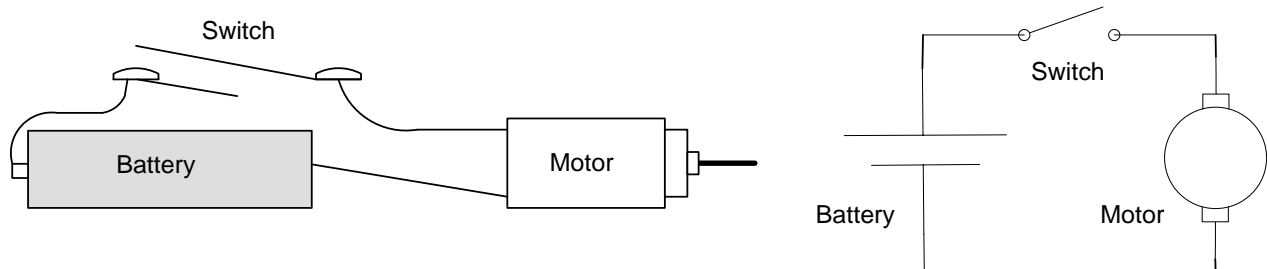

Switch interrupts circuit when open, turns LED ON when closed

This second circuit works correctly, because the switch interrupts the current when it is open, and allows current to flow from the battery to the MOTOR and back when closed. In the first case, the, MOTOR and switch are all said to be in **parallel**, because current can flow through either one if the other is removed. In the second case, the switch and MOTOR are in **series**, because current has to flow through one to get the other. Lesson 4 develops series and parallel circuits.

Another type of short circuit can occur within a switch. In this case, a switch that appears to be open is actually never open due to the short circuit, because the two metal contacts are always touching, even when they don't seem to be. The drawing below shows one way this can happen. The rotary switch appears to be open until you look underneath. The two paper fasteners are actually touching! Fortunately, the solution is very simple – just turn the legs a little, so they no longer touch.

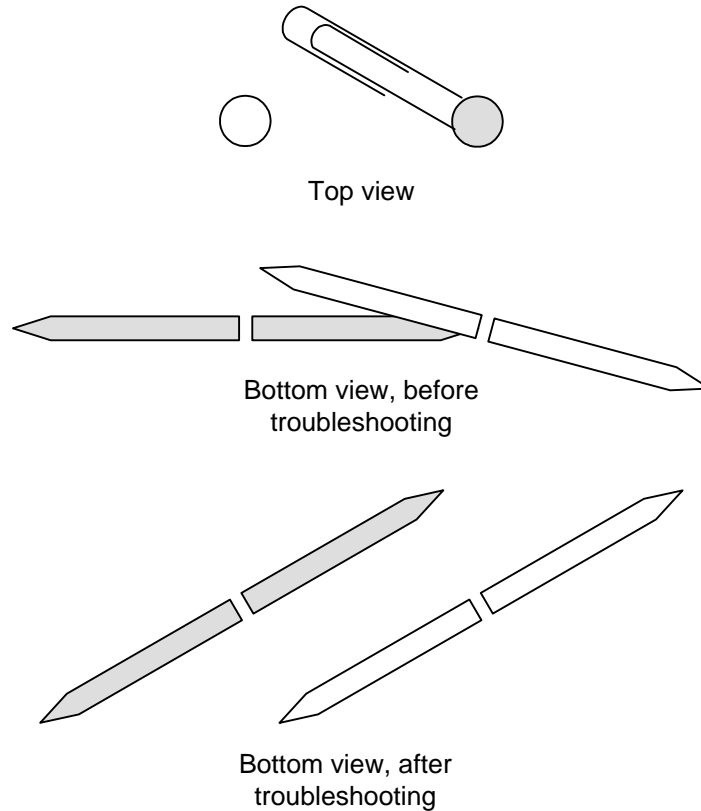

Rotary switch, which appears to be open, but is actually closed due to a short circuit underneath. Even without looking underneath, you can detect this situation using a **digital multimeter**. See the [Appendix, Part 7](#), for details.

The table below summarizes the kinds of things that can go wrong in a circuit with a switch, and what to do about each one:

Issue	Cause	Fix
Load never turns ON	Load or battery is bad	Replace load or battery
	At least one connections is bad	Re-do connection, and secure with tape or rubber band
Load never turns OFF	Switch has short circuit	Separate contacts so they don't touch
Load turns on when switch is OFF, and <i>vice versa</i> ; battery gets warm	Switch is connected across battery, and can't interrupt circuit	Rewire circuit so switch can interrupt current path

Lesson 3: Circuit diagrams

Overview

Students represent their circuits by making drawings, and then conduct a Gallery Walk to evaluate the drawings. They are likely to be hard to interpret. To solve this problem, students learn to use standard circuit symbols and conventions, and use these for representing their circuits. Then they learn to light a Light-emitting Diode (LED) from two batteries in series, and construct new circuits using circuit diagrams as guides.

Materials

- ✦ Circuits from Lesson 2
- ✦ Additional AA Batteries, Red LEDs, tape, foil, rubber bands

Procedure

1. Circuit drawings. Pose the challenge:

✦ *Suppose someone else wanted to make a circuit just like the one you made. Make a drawing of it so they will know what to do.*

Provide paper, but no further directions.

2. Gallery walk. Post the circuit drawings, and allow everybody to examine them. Then ask for comments:

✦ *How are these drawings different?*

✦ *What problems would someone have in following them?*

Elicit the observation that different students used different symbols for representing the same items. If someone doesn't know what your symbol represents, they will not know how to make what you made.

3. Symbols. Standard symbols provide a way to give information in a very small space. If everyone agrees on what the symbols mean, there is no need to explain them each time. Brainstorm examples of how symbols are used to indicate ideas such as:

✦ MALE or FEMALE rest room

✦ Things you can find on maps

✦ Street signs (BUS STOP, HOSPITAL, NO U-TURN, DANGER)

✦ How to use appliances (ON/OFF, PLAY, REWIND, FAST FORWARD, PAPER JAM, etc.)

✦ How to take care of clothing (for DO NOT IRON, MACHINE WASH COOL, DO NOT BLEACH, etc.)

✦ NO SMOKING

Then explain that there are **standard circuit symbols** that work the same way as all these other symbols. They save a lot of space, and are easy to understand, once everybody agrees on what they mean.

Introduce the standard circuit symbols (LEDs will come up in the next step):

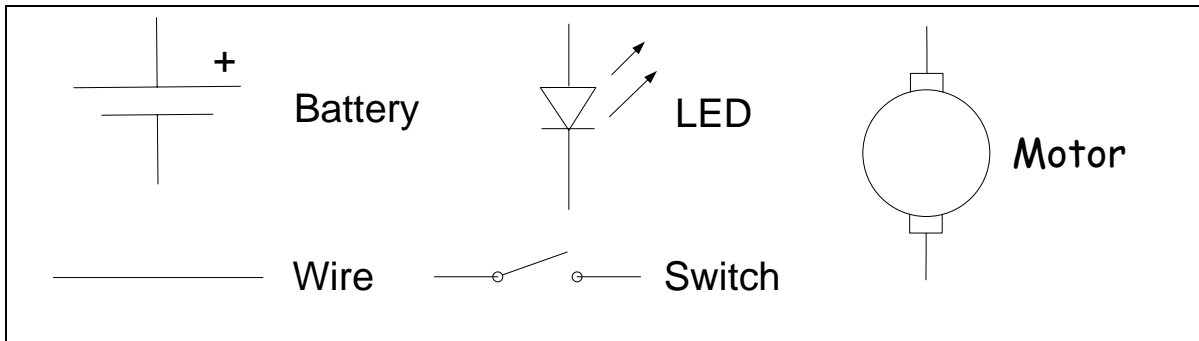

There are also some **standard rules** for using the circuit symbols. Following these rules makes the diagrams neat and easy to understand:

- ✦ Use horizontal or vertical straight lines to represent wires between circuit parts.
- ✦ Use square corners between horizontal and vertical lines.
- ✦ Put the battery on the left and the loads (LED and/ or buzzer) on the right.
- ✦ Put switches on top.

To provide practice in using the symbols and rules, draw this circuit, and ask students what parts it has and what it does. They can use the Worksheet to show their answers

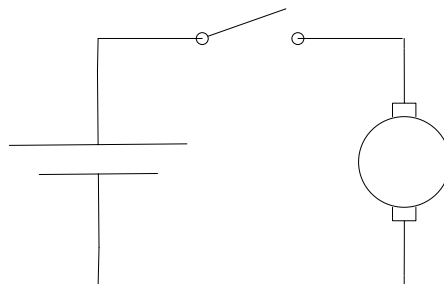

4. Comparing diagrams with drawings: Ask each student to make a diagram of the same circuit they drew earlier, this time using the standard symbols and rules. Then conduct another Gallery Walk to compare the two representations for each circuit:
 - ✦ *How do they compare?*
 - ✦ *What makes one of them easier to follow?*

5. Two circuit challenges: Here are two circuits that each includes a motor, LED and switch.

✎ *Make each of these circuits.*

✎ *Describe what it does:*

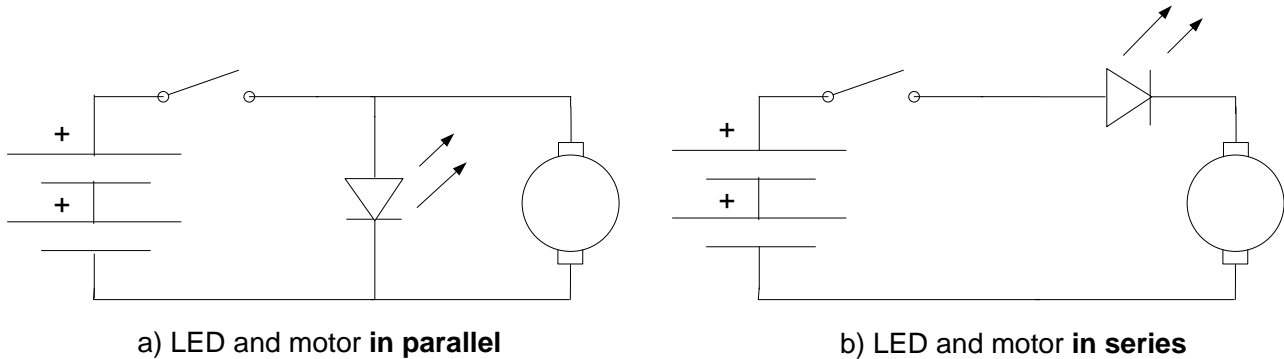

In circuit a), the LED and motor are each attached directly across the battery. Remove either one, and the other will stay on, like the lights above many medicine cabinets. They are said to be connected in **parallel**. In circuit b), the same current has to flow through the LED in order to get to the motor. These are said to be in **series**.

When the LED and motor are connected in parallel, both should turn on, because each one gets the current it needs directly from the battery. However, when they are connected in series, the LED turns on, but the motor will either not turn on or not go very fast, because the LED limits the amount of current to the motor.

Outcomes

- ✎ Diagrams are different from drawings. A drawing tries to show what things look like, but a diagram reveals its structure. Electrical diagrams use a common set of symbols and rules, which make circuit operation clear.
- ✎ Standard diagrams make circuits easier to understand and troubleshoot.
- ✎ Electrical diagrams are also useful for trying out circuit ideas, before actually building the circuits. They are excellent **design tools**.

Name: _____ Date: _____

Lesson 3: Circuit diagrams

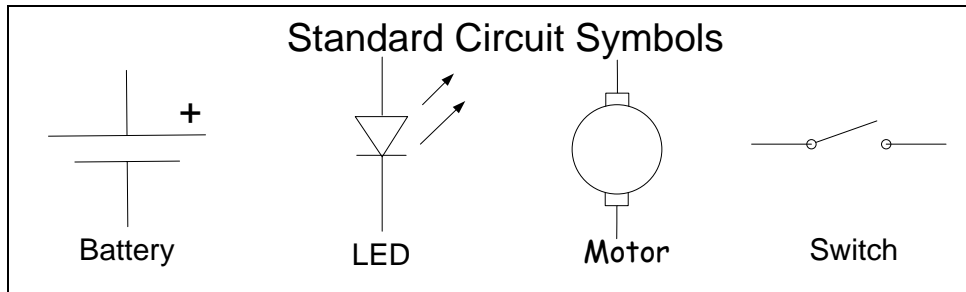

1. Here is a circuit diagram made using the circuit symbols:

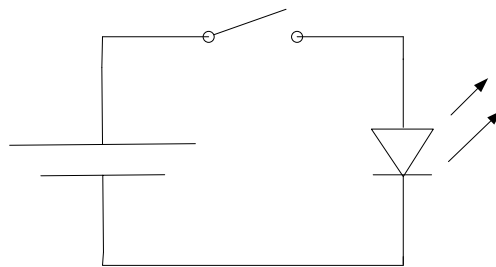

What parts does this circuit have? _____

What does this circuit do? _____

2. a) Make the circuit shown below, and describe what it does.

<p>A series circuit diagram containing a battery, a switch, an LED, and a motor. The battery is on the left, followed by the switch, then the LED, and finally the motor on the right.</p>	<hr/> <hr/> <hr/> <hr/> <hr/>
--------------------------------------------------------------------------------------------------------------------------------------------------------------------------------------------	-------------------------------

b) Make the circuit shown below, and describe what it does.

<p>A series circuit diagram containing a battery, a switch, a diode, and a motor. The battery is on the left, followed by the switch, then a diode (triangle pointing right), and finally the motor on the right.</p>	<hr/> <hr/> <hr/> <hr/> <hr/>
-----------------------------------------------------------------------------------------------------------------------------------------------------------------------------------------------------------------------	-------------------------------

Troubleshooting (for teachers only)

Why use standard symbols?

Some students are likely to resist using the standard symbols. They will continue trying to make a circuit symbol that looks like the real part. Ask whether everyone would use the same symbol for that part. If not, how would someone else know what your diagram represents? It will take time for some students to accept the need for standard symbols – be patient!

Using diagrams for troubleshooting circuits

Besides being useful for designing new circuits, the diagrams are also useful for troubleshooting. If time is available for a student to make any of the circuits he or she has designed in part 5, the diagram can be used to troubleshoot the circuit. If the circuit doesn't work, compare the diagram with the circuit to make sure that:

- ✦ every line on the diagram corresponds to a connection in the real circuit,
- ✦ that every symbol on the diagram corresponds to the real component in the circuit, and
- ✦ nothing is in the circuit that isn't in the diagram.

If all of these are true, and the circuit still doesn't work, there are only two possibilities. Either:

- ✦ some of the connections are not being made (most likely), or
- ✦ one or more of the components is bad.

You can test the connections by squeezing them or redoing them. Test a battery by connecting it directly to a load that you know is working, and test a load by connecting directly to a battery that you know is good.

Making a circuit that looks like its diagram

If students have difficulty translating between diagrams and circuits, here is an idea that might help. Make a circuit and its diagram, and then tape the components and wires of the circuit down in the same way as the diagram shows them. The correspondence between the circuit and the diagram should be obvious when these are put side-by-side. Then remove the tape, being careful not to undo any of the connections. Does the circuit work any differently? If not, shouldn't the same diagram still apply?

Lighting an LED

There are several things that can easily be overlooked when you are trying to light an LED:

- ✦ The two batteries have to be facing in opposite directions. That's because they have to be in **series**. For the voltages to add, the "+" terminal of one must be touching the "—" terminal of the second.
- ✦ The connection between the two batteries must be tight. See [Connecting to two AA batteries](#), below.
- ✦ The long wire of the LED has to touch the exposed (+) side of one battery, and the short wire has to touch the "—" side of the other battery. If the wires are reversed, the LED will not come on.

Connecting to two AA batteries

The troubleshooting section of Lesson 1 shows a method of attaching wires to a AA battery reliably. The diagram below shows a way to connect to two AA batteries.

Materials

- 2 AA batteries
- two wires, bare or stripped at least 1/2 " back
- four small paper fasteners (1")
- tape
- two rubber bands

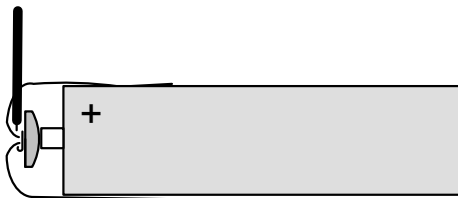
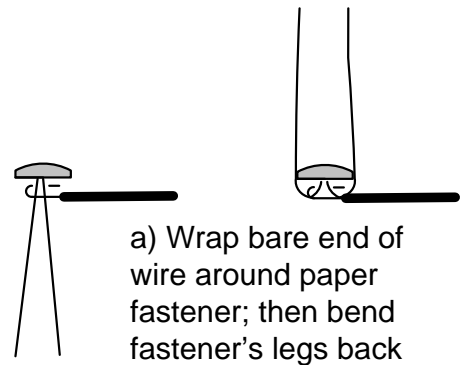

b) Place fastener legs around body of battery

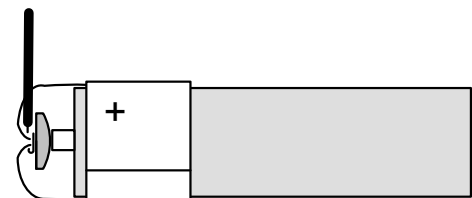

c) Press head of fastener against contact, and tape legs to side of battery

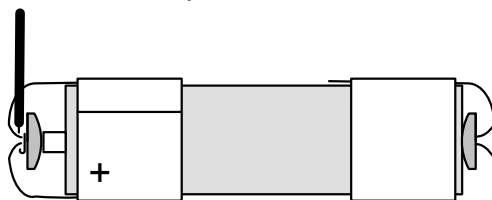

d) Attach another fastener to the other battery terminal, leaving one of the fastener's legs sticking out.

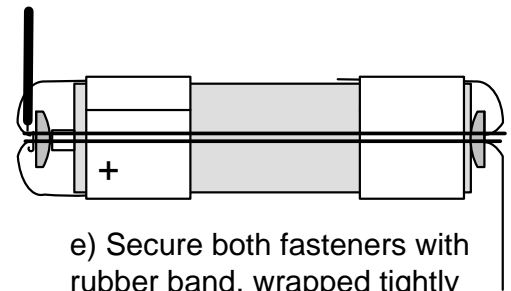

e) Secure both fasteners with rubber band, wrapped tightly around length of battery

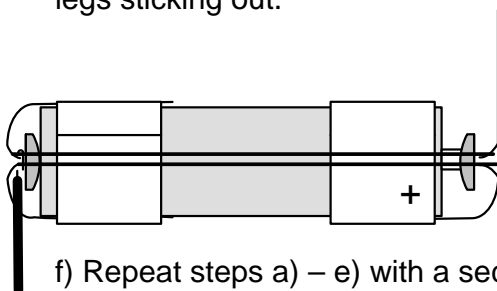

f) Repeat steps a) – e) with a second battery, wire and paper fasteners, but this time attach the wire to the (-) side and the open fastener to the (+) side of the battery

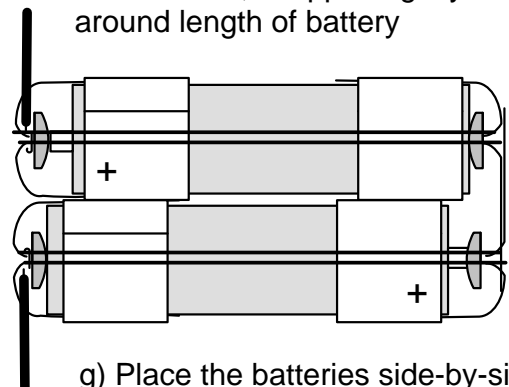

g) Place the batteries side-by-side so the paper fastener legs are touching, and tape the clegs and batteries together (tape not shown)

Series and parallel connections

Series and parallel configurations offer two fundamentally different ways to attach two loads to the same batteries, in this case LEDs. In the **parallel** connection (a), the LED and motor are directly wired to the battery. Both turn on completely, and either one will also turn on without the other.

In the series connection (b), the motor and LED split up the three volts from the battery, and share the same current. Recall from Lesson 1 that the **voltage** is the amount of energy kick each electron gets from the battery, while the **current** is the rate of flow of the electrons, which carry the energy. Both the LED and motor will turn on in the parallel connection. In the series connection, the LED lights up, but the motor turns slowly if at all. Because it has to share with the LED, the motor doesn't get enough current or voltage to operate well. What happens in each case when you remove the LED or motor ?

- ✦ Removing either load from the **parallel** circuit (a) will not affect the other very much, because it will still be connected directly to the batteries.
- ✦ Removing either load from the **series** circuit (b) will break the whole circuit, turning the other load off, because its connection to the battery is now gone.

As an example of a parallel circuit, think about the row of lights above many medicine cabinets. One or more bulbs can blow, leaving the others on, because they are all connected in parallel across the house current, which plays the same role as a battery. An example of a series circuit is the old-fashioned string of Christmas tree lights, which would go out entirely if one of the bulbs was blown or removed. Pairs of fluorescent lights in old-fashioned ceiling fixtures were also sometimes connected this way – both bulbs had to be good for either one to turn on.

Lesson 4: Let's Roll!

Overview

In order to make an electric car, you first need to make a car. In this lesson, students create cars that will roll when given a push or released on a ramp. They confront issues of friction, and develop means for reducing it; and work on how to make their cars go straight.

Materials

- ✎ Wheels (black), four per student
- ✎ Skewers, two per student
- ✎ Straw, one per student
- ✎ Cardboard rectangles, 4 ¼ " x 5 ½ ", one per student
- ✎ Cardboard sheets, 8 ½ x 11 " (for making ramps)
- ✎ Tape, scissors, paper fasteners, paper clips, bulldog clips
- ✎ Steel washers (for adding weight)

Procedure

1. Car talk: Introduce the issue of making a car that will roll easily. In the next lesson, students will be making electric cars, but to do so they will first have to create simpler cars that can roll when pushed or released on a ramp. Ask students:
 - ✎ *What parts do you think you will need to make a car?*Introduce the parts available for making cars.
 - ✎ *How will you put these parts together?*
 - ✎ *Which parts of your car will be turning and which parts will not be?*After discussing these issues briefly, provide the Worksheet, Part 1, for students to record their ideas.
2. Make a car: Provide materials for making cars, and cardboard sheets for making ramps. Students should test their cars by trying to get them to roll down ramps. It is likely that many of them will not work well. The 8 ½ x 11 " cardboard sheets may not be big enough to test the cars properly. If so, ask:
 - ✎ *What properties does a ramp need to have?*
 - ✎ *What can we find that would make a better ramp?*
3. Students can then do a scavenger hunt for a larger board that can serve as a ramp. They should record the issues on the Worksheet.
4. Class meeting: Discuss the issues that came up. Introduce the words **axle** for the stick that holds the wheels, and **body** for the cardboard platform. If something won't move when you push it or let it go on a ramp, **friction** is preventing it from going. You reduce friction by allowing the wheels to roll. Ask:

- ✎ For the car to roll, which parts need to be able to turn?
- ✎ Which parts should not be able to turn?
- ✎ How can you allow one part to turn, while the other part doesn't?

Develop the idea that the wheels need to turn, but the body can't turn. There are two possibilities:

- ✎ The wheels can be fixed to the axles, but then the axles have to be able to turn freely while the body is not turning; or
- ✎ The wheels can be loose on the axles, allowing them to rotate freely. This allows the axles to be fixed to the body, but then there needs to be something to stop the wheels from falling off.

Lead a discussion about how to solve the problems of either:

- ✎ Allowing the axles to rotate, or
- ✎ Keeping the wheels on the axles.

Then provide time for students to troubleshoot their cars, and redesign them if necessary.

5. Straight or crooked? Once students get their cars to roll, there are still likely to be some issues. A major one will probably be that many cars will not travel in a straight line. (Other issues are addressed in the Troubleshooting section, below). Ask students:

- ✎ If you're pedaling a bicycle or tricycle, or pulling a wagon, what do you need to do to make it turn?
- ✎ What has to happen for a wagon or tricycle to go straight?

Use charts to develop the idea that a vehicle go straight if the two axles are **parallel**, and will go crooked if the axles are not parallel. See diagrams below:

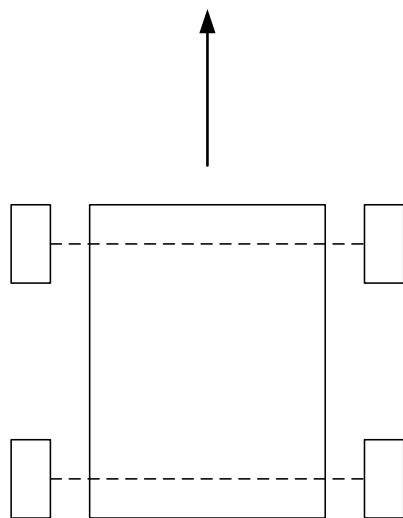

a) Axles are parallel; car goes straight

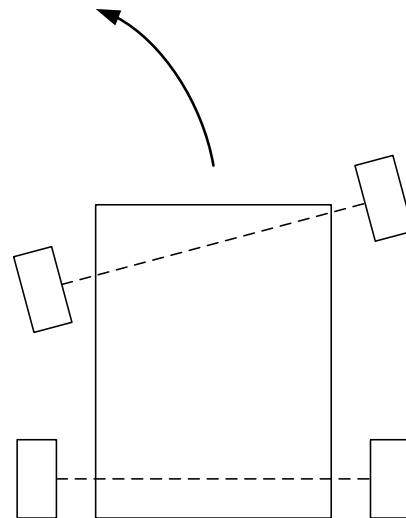

b) Axles are not parallel; car curves

Provide additional time for students to address this problem, and then use the Worksheet, Part 2 to write a **Troubleshooting Guide** and a **Construction Manual**.

Outcomes

- ‡ Something that can roll will move more easily than something that can't.
- ‡ Friction prevents something from moving easily. You have to reduce friction to allowing one part to turn while another does not.
- ‡ In order to go straight, the axles of a vehicle have to be parallel to each other.

Name: _____ Date: _____

Lesson 4, Part 1: Designing a Car

Circle the parts you will use to make a car:

wheels

skewer

straw

cardboard

tape

rubber band

How will you assemble the parts to make the car (draw and write) ?

Label each part	<hr/> <hr/> <hr/> <hr/> <hr/> <hr/> <hr/> <hr/> <hr/> <hr/>
-----------------	-------------------------------------------------------------

Which parts will be able to turn ? _____

Which parts will be not able to turn ? _____

Test your car on a ramp. What issues are there?

1. _____

2. _____

3. _____

4. _____

Name: _____ Date: _____

Lesson 4, Part 2: How to Make a Car

1. **Troubleshooting Guide:** How did you solve each issue?

Issue	Fix
<hr/> <hr/>	<hr/> <hr/>
<hr/> <hr/>	<hr/> <hr/>
<hr/> <hr/>	<hr/> <hr/>

2. **Construction Manual:** draw and explain what to do in each step:

<hr/>	<hr/> <hr/> <hr/>
<hr/>	<hr/> <hr/> <hr/>
<hr/>	<hr/> <hr/> <hr/>
<hr/>	<hr/> <hr/> <hr/>

Troubleshooting (for teachers only)

The table below shows how to address a variety of issues that can come up in making cars. Do not share any of these ideas directly with students. Provide just enough information to prevent frustration. The best way to do this is to ask questions, such as, “What should be able to turn?” Each issue may have more than one possible cause, so multiple causes are listed for some of the issues, as well as a fix for each one.

Issue	Possible Causes	Fixes
Wheels won't turn	Wheels are fixed to axles and axles are fixed to body	Use straws or paper fasteners to allow axles to rotate freely
	Wheels are rubbing against body or against straw	Move wheels outwards on axle, further away from body
Wheels come off	Wheels free to slide on axles	Use a little clay, tape or rubber bands at ends of axles to stop wheels from leaving
Wheels turn a little, then stop	Wheels have burrs (high spots)	Use nail file or abrasive pad to file off high spots
Car goes slower than others	Too much friction	Use straws or paper fasteners to allow wheels to turn more freely
	Too much weight	Reduce amount of material or use lighter materials
Car does not go as far as others	Too little weight	Add weights, such as steel washers
Car bounces or vibrates as it goes down ramp	Axle is bent	Replace axle with a straight skewer
Car turns rather than going straight	Axles are not parallel	Reposition axles to make them parallel
	More friction on one side	Check to see that wheels can turn equally freely on both sides; if not, reduce friction on slow side

Lesson 5: The Direct-drive Car

Overview

Students make cars that work by having the motor driving a wheel directly.

Materials

- ✦ Motor, AA battery, skewers, straw, wheel (red, yellow, blue or green), bushing – one of each per student
- ✦ Aluminum foil, galvanized wire, rubber bands, paper fasteners, paper clips, bulldog clips, tape, cardstock (for making switches and connections)
- ✦ Switches made previously by students (Lesson 2)
- ✦ Wheels (black) – two per student
- ✦ Cardboard rectangles, 4 ¼ " x 5 ½ ", and cardboard strips 11 " x 1 "
- ✦ Steel washers (for adding weight)
- ✦ Two-gallon reclosable plastic bags for storing work-in-progress, one per student

Procedure

1. Brainstorming electric cars: Review what students have done so far:

- ✦ They have gotten a motor to run from a battery;
- ✦ They have learned how to control a motor using a switch; and
- ✦ They have made a car that can run by gravity.

The next challenge is to make a car that runs from a motor. Ask:

- ✦ What are some ways that you the motor could be used to make the car go?

Students may suggest using a propeller, attaching a wheel to the motor, using gears, using pulleys, etc. There are three ways we'll be exploring in this class:

- ✦ **Direct-drive**: A wheel is attached directly to the motor. By turning this wheel, the motor makes the car go, like someone pedaling a bicycle or tricycle.
- ✦ **Propeller-drive**: A propeller is attached directly to the motor. The air blown by the propeller makes the car go, like a propeller-driven plane or boat.
- ✦ **Belt-drive**: The motor turns a **pulley**, which is connected to another pulley by a rubber **belt**. The second pulley is what makes the car go. The belt is similar to the chain on a bicycle, and the two pulleys are similar to a bicycle's sprockets, one on the pedals, and the other on the rear wheel. The differences between pulley-belt and sprocket-chain systems are that a belt is made of smooth rubber, and the pulleys have smooth surfaces.

Explain that we'll begin by making direct-drive cars. There will be time later to make at least one of the other types.

2. How does a direct-drive car work? Explain that the large wheel will be the one that makes the car go. It will have to fit tightly on the motor, so that when the motor turns, the wheels turns with it. Show what happens when you try to put the wheel directly on the motor shaft. It is too loose. Demonstrate how the bushing makes a tight fit between the motor shaft and the wheel. Now the motor can transmit power directly to the wheel, which will make the car go. Then present the challenge:
✎ Design a car that will be driven by the wheel that's turned by the motor.
3. What parts will you need? Distribute worksheets. Ask students to list the materials that they think they will need, and to draw and describe their preliminary ideas.
4. Making direct-drive cars: Distribute materials. Explain that each car will need to have a switch so it can be turned ON or OFF. Provide time for students to work on their cars. On the Worksheet, they should list the issues that come up

Outcomes

- ✎ A wheel can drive a car, but only if it fits tightly on the motor.
- ✎ A car needs at least three wheels to support it.
- ✎ The wheels that are not driven by the motor need to be able to rotate freely.

Name: _____ Date: _____

Lesson 5: Designing a Direct-drive Car

List the parts you will need to make a direct-drive car:

_____	_____
_____	_____
_____	_____
_____	_____
_____	_____

How will you assemble the parts to make the car (draw and write) ?

Label each part	_____

How will the motor make the car go ? _____

Test your car. What issues are there?

1. _____
2. _____
3. _____
4. _____

Troubleshooting (for teachers only)

The table below shows how to address a variety of issues that can come up in making direct-drive cars. Do not share any of these ideas directly with students. Provide just enough information to prevent frustration. The best way to do this is to ask questions, such as, “What should be touching the ground?” Each issue may have more than one possible cause, so multiple causes are listed for some of the issues, as well as a fix for each one.

Issue	Possible Causes	Fixes
Motor won't turn	Connections are bad – metal surfaces aren't touching. Test them with a digital multimeter . See the Appendix , Part 7.	Review how to make connections – see “Connecting to an AA battery” under Troubleshooting , Lesson 3
	Switch not working (test by putting a wire across the switch)	Review requirements for a switch & types of switches, Troubleshooting , Lesson 2.
	Battery is dead. Test for this by changing to another battery, or by using a digital multimeter – see the Appendix ., Part 3.	Test battery by holding motor wires directly against terminals. If motor still doesn't come on, battery is dead. Replace it.
	Motor is bad. Check to see if you can turn the shaft by hand. If not, friction is preventing it from working.	Use another motor
Motor spins, but doesn't turn wheel	Wheel is not attached tightly to motor	Push bushing into wheel, and push motor shaft into bushing, for tight fit
Wheel spins when off the ground, but doesn't drive car when on the ground	Wheels are too high	Wheels must be resting on the ground. Make axle and/or motor ride lower.
	Too much friction in the wheels that are not attached to the motor	Make sure wheels can spin on axle, or axle can spin on body; see Troubleshooting , Lesson 4.
	Wheel and motor tip when car is on the ground	Attach motor more firmly to car body
Wheels come off	Wheels free to slide on axles	Use a little clay, tape or rubber bands at ends of axles to stop wheels from leaving
Car goes in circles	Axles are not parallel	Reposition axles to make them parallel
	More friction on one side	Check to see that wheels can turn equally freely on both sides; if not, reduce friction on slow side
Car goes backwards	Motor is turning in the wrong direction	Reverse the wires from the motor, or to the battery (see Lesson 1, step 3)
Car tips over	Weight is unbalanced	Add weights, such as steel washers; move battery; or redesign body so weight is better

		distributed
--	--	-------------

Lesson 6: Troubleshooting a Direct-drive Car

Overview

Students continue working on their direct-drive cars. As they do so they develop and record their troubleshooting strategies.

Materials

- ✦ Same as for Lesson 5: Motors, AA batteries, skewers, straws, wheels, bushings, Aluminum foil, galvanized wire, rubber bands, paper fasteners, paper clips, bulldog clips, tape, cardstock, cardboard rectangles and strips, steel washers
- ✦ Partially completed cars from Lesson 5

Procedure

1. What is troubleshooting? Many of the students' cars will likely still not be working at this point. Conduct a class meeting about how to address these problems. Ask:

✦ If something doesn't work the way you want it to, what should you do?

Develop the idea that it doesn't make sense to start over, because most of what you made is probably OK. Also, if you start over, you might just run into the same issue again! It makes much more sense to:

- ✦ Find out exactly what is preventing it from working, and
- ✦ Then solve only that problem.

In engineering, this way of addressing issues is called **troubleshooting**. For suggestions about how to fix a direct-drive, see Troubleshooting section, Lesson 5.

As part of Lesson 4, students should have begun compiling lists of issues. Make a chart with the heading, "Troubleshooting," write down an issue from the list and under it two columns labeled "Cause" and "Fix." Ask students what they think is causing one of the items on the "Issues" list, and record it in the "Cause" column. Model one or two entries on this chart, like the one below: Then ask what they did or could do about that problem, and put the answer under "Fix." Sometimes it's easier to go the other way – Figure out the "Fix" first, and then decide what the "Cause" was. Model this process, by creating one entry on the chart, something like this:

Direct-drive-Car Troubleshooting Chart

Issue: Wheel spins when off the ground, but doesn't drive car when on the ground	
Possible Cause	Fixes
Wheels are too high	Wheels must be resting on the ground. Make axle and/or motor ride lower.
Too much friction in the wheels that are not attached to the motor	Make sure wheels can spin on axle, or axle can spin on body; see <u>Troubleshooting</u> , Lesson 4.
Wheel and motor tip when car is on the ground	Attach motor more firmly to car body

2. Complete a direct-drive-car and a Troubleshooting Guide. Students continue to build their direct-drive-cars. They list any issue that arises on the Worksheet, as well as the cause and the fix.

Outcomes

- ✦ To fix a problem, first you have to know what's causing it.
- ✦ Friction can prevent things from moving, and can be reduced by preventing things from rubbing each other.
- ✦ Electrical connections must be tight for current to flow in a circuit.
- ✦ Mechanical connections must be tight in order to transmit power.

Name: _____ Date: _____

Lesson 6: Direct-drive-Car Troubleshooting Guide

<u>Issue:</u>	
<u>Cause:</u> _____ _____ _____	<u>Fix:</u> _____ _____ _____

<u>Issue:</u>	
<u>Cause:</u> _____ _____ _____	<u>Fix:</u> _____ _____ _____

<u>Issue:</u>	
<u>Cause:</u> _____ _____ _____	<u>Fix:</u> _____ _____ _____

<u>Issue:</u>	
<u>Cause:</u> _____ _____ _____	<u>Fix:</u> _____ _____ _____

Lesson 7: How to Build a Direct-drive Car

Overview

Based on the steps they actually followed in making one, each student writes an illustrated **Instruction Manual** that could show someone how to make a direct-drive car. The teacher and other students test each student's manual by following each step literally.

Materials

- ✦ Direct-drive cars already made by students
- ✦ Materials for making cars, for use as spare parts.

Procedure

1. Class meeting: Students may already be familiar with How-to Books. An engineering term for a How-to Book is an **Instruction Manual**. Meet with students to discuss what an instruction manual is and how it can be used:
 - ✦ Someone else might want to make what you made, and you might not be around to show them. Your Instruction Manual will tell them how to make one.
 - ✦ You might want to make one yourself at a later date, but by then you might have forgotten how to do it. Your Instruction Manual will remind you about what to do.
2. Writing instruction manuals. Provide time for each student to write his or her own Instruction Manual.
3. Testing instruction manuals. After students have finished writing, demonstrate how to test an Instruction Manual. Select an instruction that is vague, such as “Put the motor on the car” and deliberately misinterpret it; for example, by placing the motor so the shaft is pointing up. Ask students:
 - ✦ *What could happen if someone tries to follow an instruction that does not give enough information?*Then ask students to exchange manuals in their groups, and test them to see if they give all the information that's needed.
4. Revising instruction manuals. Ask students to revise their instruction manuals to provide all the information that is needed. This could be a homework assignment.

Outcomes

- ✦ An instruction manual will tell someone else how to do what you did.
- ✦ Writing and diagrams have to be clear and precise, or they will not be useful.
- ✦ Writing and diagramming are design processes. You can analyze the weaknesses in your writing and diagrams, and redesign them to make them work better.

Name: _____ Date: _____

Lesson 7: Instruction Manual for Making a Direct-Drive Car

Number each step. Use more pages if necessary

<hr/>	<hr/> <hr/> <hr/> <hr/> <hr/> <hr/> <hr/> <hr/>
-------	-------------------------------------------------

<hr/>	<hr/> <hr/> <hr/> <hr/> <hr/> <hr/> <hr/> <hr/>
-------	-------------------------------------------------

<hr/>	<hr/> <hr/> <hr/> <hr/> <hr/> <hr/> <hr/> <hr/>
-------	-------------------------------------------------

Lesson 8: Make a Belt-drive or Propeller-drive Car

Overview

In this lesson, students begin making a different type of car. There are two options: the belt-drive (Option B) and propeller-drive (Option P). Teachers may decide to do one or the other, provide both options to the students, or extend the unit by two lessons and do both.

Materials (for both options)

- ✦ Same materials for making cars as in Lessons 5 & 6: Motors, AA batteries, skewers, straws, wheels, bushings, Aluminum foil, galvanized wire, rubber bands, paper fasteners, paper clips, bulldog clips, tape, cardstock, cardboard rectangles 4 ¼ " x 5 ½ ", cardboard strips 11 " x 1 ", steel washers
- ✦ Additional materials: Propellers, plastic spools, foam blocks, cardboard rectangles 5 ½ " x 8 ½ "; re-closable 2-gallon storage bags

Procedure

1. Two new kinds of car: Review the previous discussion of drive systems from Lesson 5. There are other ways to get a motor to drive a car besides direct-drive: you can use a propeller, gears (as most Lego Technic™ constructions), pulleys & belt (found inside a washing machine), sprockets & chain (as in a bicycle), and others. Students will have the option of making cars based on either of two drive systems: the belt-drive or the propeller-drive. Review each one briefly:
 - ✦ **Propeller-drive**: A propeller is attached directly to the motor. The air blown by the propeller makes the car go, like a propeller-driven plane or boat.
 - ✦ **Belt-drive**: The motor turns a **pulley**, which is connected to another pulley by a rubber **belt**. The second pulley is what makes the car go. Although the parts are different, the idea is similar to the sprockets and chain of a bicycle.

Students should select which one they want to make.

2. **Option P** Design a propeller-drive car: Show students a propeller and ask:

✦ *How could this be mounted on a motor?*

✦ *How could the motor be mounted on a car?*

As they come up with idea, suggest they make diagrams on the blackboard or chart paper, for everyone to discuss. Additional questions might be:

✦ *How could you use the simple car from Lesson 4?*

✦ *How could you predict the direction the car would go?*

✦ *What kinds of things would you have to look out for?*

Students will probably suggest attaching the propeller to the motor shaft, and letting the air flow push the car. Since the motor and propeller will be doing all the work, the car

could be the simple one from Lesson 4. Provide worksheets for students to record their ideas.

Option B Design a belt-drive car: Mount a bushing on a motor shaft, and use a pencil to support a spool. The spool should be able to rotate. Show students how a rubber band can be looped over both the shaft and the spool. If the rubber band is stretched slightly, turning the motor shaft will also turn the spool. Have a student help you show this by rotating the bushing by hand while you hold the motor and spool. See diagram below. The two pulleys are the motor shaft and spool, and the rubber band is the belt.

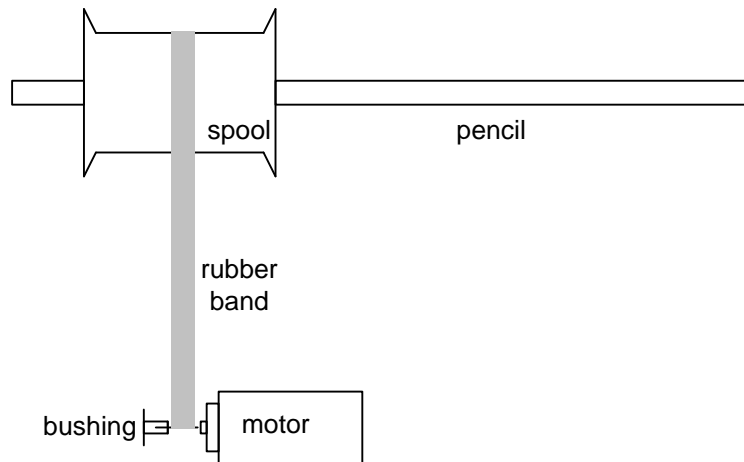

How a motor can drive a pulley (spool) through a belt (rubber band)

Ask:

✎ *Suppose the motor was on and turning the spool, like I just showed you. How could you use this spool to drive a car?*

A simple way is to make the spool do double duty as a wheel. That way it can drive the car without having a tight connection to an axle and wheels. Another way is to make the axle fit snugly in the spool, and attach the axle to wheels snugly at either end. In this design, the spool turns the axle, which will make the wheels turn too.

3. Issues list: As students are working, ask them to record issues as they come up. The Worksheet provides space for recording them. If time permits, conduct a class meeting to discuss some of the issues for either or both types of car.

Outcomes

- ✎ There are a variety of ways to make a motor drive a car.
- ✎ A propeller makes a car go by pushing air in one direction. The car goes in the opposite direction.
- ✎ A belt-pulley system transfers motion from one place to another.

Name: _____ Date: _____

Lesson 8 (Option P): **Designing a Propeller-drive Car**

List the parts you will need to make a propeller-drive car:

_____	_____
_____	_____
_____	_____
_____	_____
_____	_____

How will you assemble the parts to make the car (draw and write) ?

Label each part	_____

How will the motor make the car go ? _____

Test your car. What issues are there?

1. _____
2. _____
3. _____
4. _____

Name: _____ Date: _____

Lesson 8 (Option B): Designing a Belt-drive Car

List the parts you will need to make a belt-drive car:

_____	_____
_____	_____
_____	_____
_____	_____
_____	_____

How will you assemble the parts to make the car (draw and write) ?

Label each part	_____

How will the motor make the car go ? _____

Test your car. What issues are there?

1. _____
2. _____
3. _____
4. _____

Troubleshooting

Option P

The propeller-drive car is easy to make, but hard to get to work. It's easy to make because it consists of the free-rolling car from Lesson 4, with a motor, propeller, battery and switch mounted on top. It's hard to get it working because the air flow is not powerful enough to overcome much friction. Also, the propeller needs to be mounted high off the ground, so it won't scrape, which makes it harder to make the vehicle stable against tipping over. Here is a troubleshooting guide for your use. Do not share this directly with the students!

Issue	Possible Causes	Fixes
Motor & propeller won't turn even when motor & propeller are removed from car	Battery connections are bad – metal surfaces aren't touching. Test them with a digital multimeter . See the Appendix , Part 4.	Review how to make connections – see “Connecting to an AA battery” under Troubleshooting , Lesson 3
	Switch or connection to switch is not working. Test them with a digital multimeter . See the Appendix , Part 7	Review requirements for a switch & types of switches, Troubleshooting , Lesson 2.
	Battery is dead. Test it with a digital multimeter . See the Appendix , Part 3.	Test battery by connecting a motor that you know is good directly against the battery terminals. If the good motor still doesn't come on, the battery must be dead. Replace it.
Motor & propeller turns when removed from car, but not when attached to car	Propeller is hitting other parts of the car	Move motor & propeller so it isn't hitting
	Propeller is hitting the ground	Raise motor and propeller so they don't hit
Propeller and motor come loose when attached to car	Motor is not attached tightly enough	Use more tape or make a pocket in the car body for holding motor
Propeller rotates but does not drive car	Car is too heavy	Remove material or use lighter materials
	Too much friction between wheels and body	Allow wheels to spin freely, as in Lessons 4 & 5
	Car body obstructs air flow	Remove material from behind propeller
Car goes in circles	Axles are not parallel	Reposition axles to make them parallel
	More friction on one side	Check to see that wheels can turn equally freely on both sides; if not, reduce friction on slow side
Car goes backwards	Motor is turning in the wrong direction	Reverse the wires from the motor, or to the battery (see Lesson 1, step 3)
Car tips over	Weight is unbalanced	Add weights, such as steel washers; move battery; or redesign body so weight is better distributed

Option B

The belt-drive car is harder to make, but once it is working, it is typically the most powerful of the three designs, though not nearly as fast as the direct-drive car.

The figure below shows a basic design.

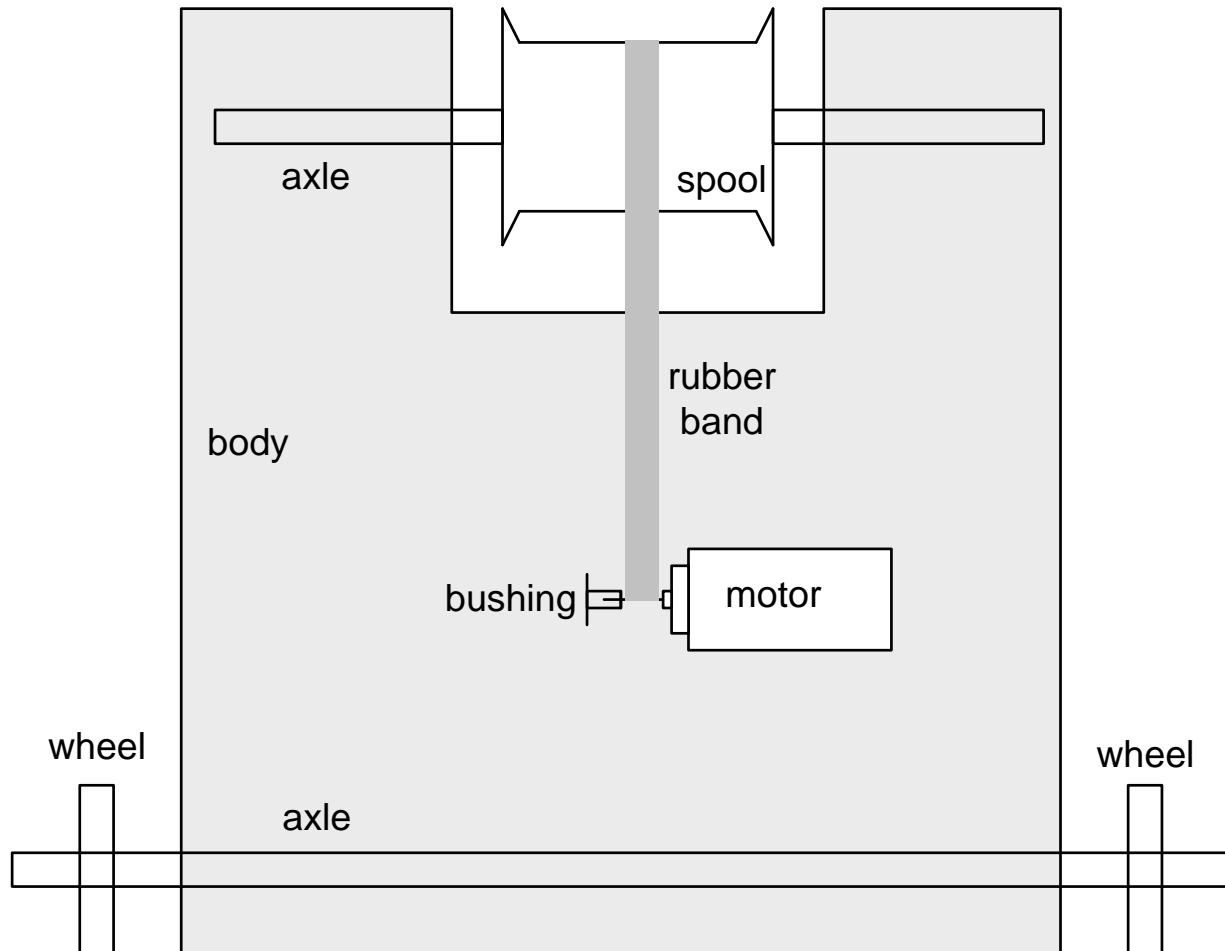

In this basic design, the spool is both a pulley and a wheel. The cardboard body has a notch to fit the pulley, which is mounted on an axle that allows it to turn. The two black wheels at the bottom of the diagram have to be able to rotate also.

A more complex design is to attach two wheels to the axle that holds the spool. In this design, the two additional wheels have to make the car go, so they have to have larger diameters than the pulley, and the pulley, axle and both wheels have to rotate together. This design also requires a way to hold the axle to the body while allowing it to rotate – a **bearing** – which can be made using two pieces of a straw. Construction is more complex too: the axle, pulley and straw pieces and rubber band have to be assembled first, before attaching the straws to the body.

Troubleshooting

Many of the possible problems, such as friction and poor electrical connections are the same as with the direct-drive and propeller cars, and are not repeated here. The Troubleshooting Chart below is specific to the problems of the belt-drive car, and does not include the problems of the more complex design described in the last paragraph:

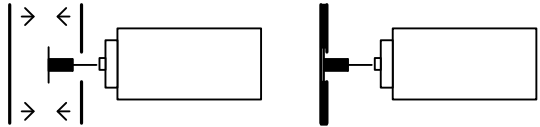
Issue	Possible Causes	Fixes
Rubber band slips off	Motor not secure enough	Attach motor more tightly, using tape or a pocket in the body
	Rubber band too loose	Move motor further back or use shorter rubber band
	Pulleys not aligned	Reposition motor or spool
	Bushing rim is not high enough	<p>Add tape to build up the end of bushing. The diagrams below show two pieces of tape, one on the inside and one on the outside of the bushing rim. Stick these together to form a bigger rim, trim excess.</p> 
Motor turns when rubber band is off, but not when rubber band is in place	Rubber band too tight	Move motor towards pulley, or pulley towards motor; or use longer rubber band
	Rubber band rubs against body	Cut larger notch in body or raise motor
	Spool can't rotate	Cut wider notch or use smaller axle
Rubber band rotates spool, but spool won't drive car	Spool slips on the ground; there are no other wheels	Run car on rougher surface, add rubber band "tires" to edges of spool, or use more complex design with separate wheels
	Spool is not touching the ground, because wires or battery are dragging below bottom of spool	Tape battery and wires securely to body; move battery if necessary

Lesson 9: Troubleshooting and Redesign of Belt-drive & Propeller-drive Cars

Overview

This lesson provides time for students to continue work on their second electric cars. Each student produces a troubleshooting guide for the car they have gotten to work.

Materials

- ↳ Partially completed cars from Lesson 8
- ↳ Additional materials (as in Lesson 8) for redesigning and rebuilding cars
- ↳ Re-closable 2-gallon storage bags to hold work-in-progress.

Procedure

1. Review of issues: Meet with the class briefly to review the issues on the list compiled at the end of Lesson 8. Ask students to share their ideas for solving these issues. Remind them to record their ideas and findings in their Science Notebooks.
2. Troubleshooting, redesigning and rebuilding cars: Provide time for students to continue working on their cars. Provide troubleshooting assistance only as absolutely necessary – by this point, students should be able to do their own troubleshooting or ask one another for assistance.
3. Troubleshooting Guide: Based on the problems they have learned to solve, each student should write a **Troubleshooting Guide** for his or her new car. The Worksheet provides a format.

Outcomes

- ↳ A Troubleshooting Guide will capture what you have learned about making a complex system work.

Name: _____ Date: _____

Lesson 9 (Option P):
Propeller-drive-Car Troubleshooting Guide

<u>Issue:</u>	
<u>Cause:</u> _____ _____ _____	<u>Fix:</u> _____ _____ _____

<u>Issue:</u>	
<u>Cause:</u> _____ _____ _____	<u>Fix:</u> _____ _____ _____

<u>Issue:</u>	
<u>Cause:</u> _____ _____ _____	<u>Fix:</u> _____ _____ _____

<u>Issue:</u>	
<u>Cause:</u> _____ _____ _____	<u>Fix:</u> _____ _____ _____

Name: _____ Date: _____

Lesson 9 (Option B):
Belt-drive-Car Troubleshooting Guide

<u>Issue:</u>	
<u>Cause:</u> _____ _____ _____	<u>Fix:</u> _____ _____ _____

<u>Issue:</u>	
<u>Cause:</u> _____ _____ _____	<u>Fix:</u> _____ _____ _____

<u>Issue:</u>	
<u>Cause:</u> _____ _____ _____	<u>Fix:</u> _____ _____ _____

<u>Issue:</u>	
<u>Cause:</u> _____ _____ _____	<u>Fix:</u> _____ _____ _____

Lesson 10: IMP(rove) your Ride: Add a Horn & Lights

Overview

In Lesson 3, students have already learned how to power a LED and a motor from the same pair of AA batteries. This lesson introduces coin batteries and buzzers, which can be used to run LEDs and buzzers in a circuit or circuits that are independent of the motor circuit. Students use these devices to improve their vehicles, by adding lights and horns plus switches to control them.

Materials

- ✦ Cars previously made in Lessons 8 & 9:
- ✦ Materials for adding lights and horns: LEDs, buzzers, coin batteries, paper fasteners, paper clips, aluminum foil, galvanized wire, rubber bands, cardstock, scissors, tape, foam, cardboard rectangles 4 ¼ " x 5 ½ "
- ✦ Re-closable 2-gallon storage bags to hold work-in-progress.

Procedure

1. Coin batteries, lights and buzzers. Provide these components. Ask students to get the LEDs to light and the buzzers to sound. Each one can work from a single coin battery, and some will work in combination. Encourage students to explore the combinations:
 - ✦ *What do you need to do to make the light come on?*
 - ✦ *How can you get more than one LED to light up from a single coin battery? What combinations will work?*
 - ✦ *How can you make the buzzer sound?*
 - ✦ *How can you operate the buzzer and a light from the same coin battery?*
2. Brainstorming ideas for IMP(roving) your Ride. Once students have learned to make circuits with LEDs, buzzers and coin batteries, encourage them to think about how these could improve their cars.
 - ✦ *How could you use these to make lights and horns for your car?*
 - ✦ *How would you turn the lights and horn ON and OFF?*

Provide worksheets for students to begin thinking about these questions. Remind them to use standard schematic symbols and diagrams to show their ideas. Some decisions students will need to make are:

- ✦ *How many lights will you need?*
- ✦ *Will the lights run off the same battery as the motor, or a different battery?*
- ✦ *What kind of switch will you use? Where will you put it?*
- ✦ *Will you also add a horn? If so, what circuit will it be in? How will you control it?*
- ✦ *What changes will you need to make to the car body and circuit to include lights and/or a horn?*

3. Working on circuits for lights and horns: Provide students with materials, so they can begin working on their improved cars. Much of this work is likely to be self-directed, and students should be able to help one another. Intervene only when necessary to help students avoid frustration.

Outcomes

- ↳ A system can include more than one circuit.
- ↳ Designing a system include making a plan as well as circuit diagrams.
- ↳ Different kinds of loads have different requirements.
- ↳ Every circuit needs its own switch.

Name: _____ Date: _____

Lesson 10, Part 1: Plans

What improvements would you like to make to your car? List them:

_____	_____
_____	_____
_____	_____

What parts will you need to make these improvements?

_____	_____
_____	_____

What changes will you make to the car body? _____

Make a plan showing where all the major parts will be, including the ones that are already there, and the new ones you will add. Show the motor, batteries, lights, switches and any other important parts. Label each part. Use additional paper if necessary.

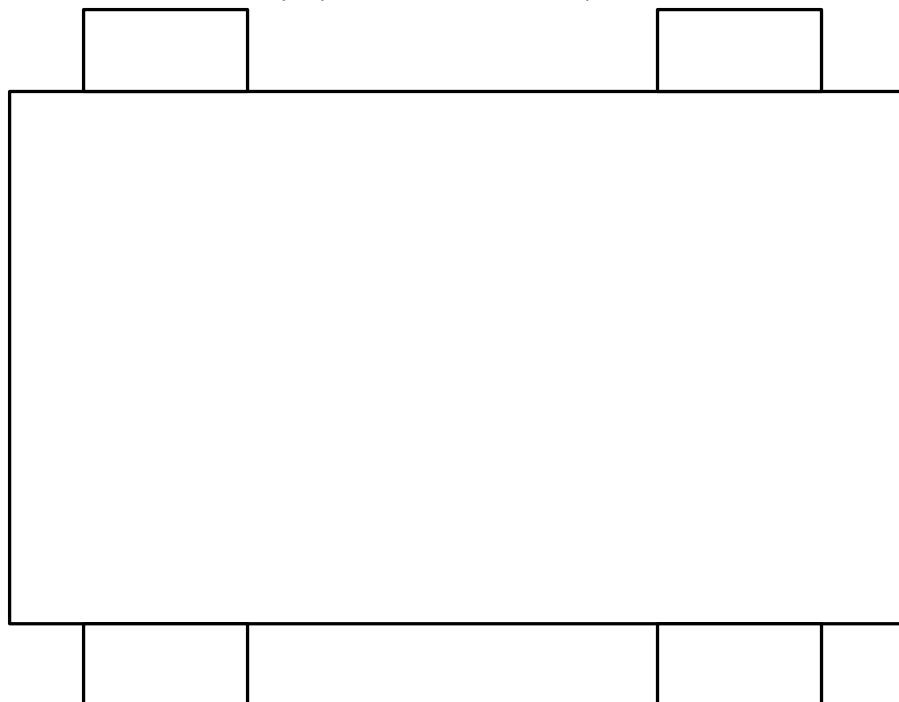

Name: _____ Date: _____

Lesson 10, Part 2: **Circuits**

How many separate circuits will you use? _____

How will you control them? _____

For each one, list the type of battery (AA or coin), the types of loads (motor, LEDs - colors & how many of each, buzzer) and the type of switch (push button, rotary, slide, toggle):

	Type of Battery	Type(s) of Load(s)	Type of switch
1			
2			
3			
4			

On this & the next page, draw a diagram for each of your circuits, using the standard symbols. Label each diagram with the circuit #.

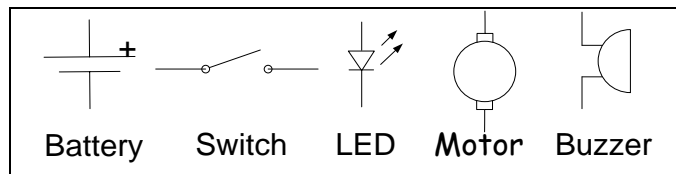

Circuit # _____

Name: _____ Date: _____

Lesson 10, Part 3: Circuits, Continued

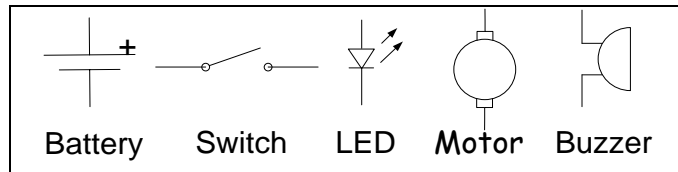

Circuit # _____

Circuit # _____

Circuit # _____

Troubleshooting

Powering a LED or a buzzer from a coin battery

The flat side of the coin battery is the (+) terminal. To light a LED, the long wire needs to connect with the (+) terminal, and the short wire should have to touch the (—) side. Like a LED, a buzzer is **polar** – it does not work unless the current is going in the right direction. The red wire has to be attached to the (+) side of the battery and the black wire has to go to the (—) terminal. Either a buzzer or a LED will also work from two AA batteries in series (see Lesson 3), but it is much easier to connect them to coin batteries.

Series and parallel circuits

To operate more than one LED from a coin battery, the LEDs have to be in parallel. The same is true for an LED and a buzzer – they will work in parallel, but not in series. Even in parallel, some LED combinations won't work. Two of the same color will always work together, and red works with yellow, but if you put green in parallel with either red or yellow, the green one won't light up.

Series and parallel circuits are summarized below (switches are not shown):

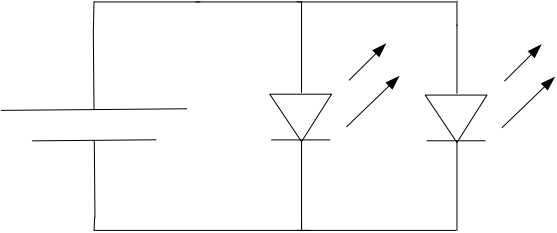
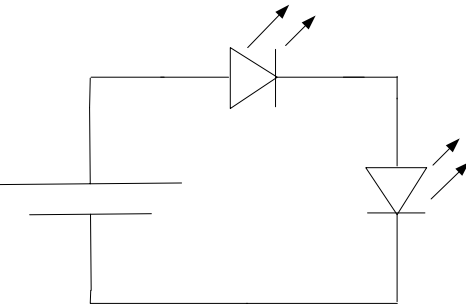
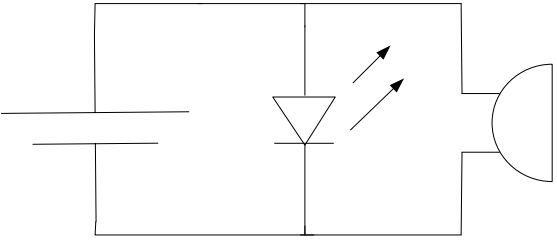
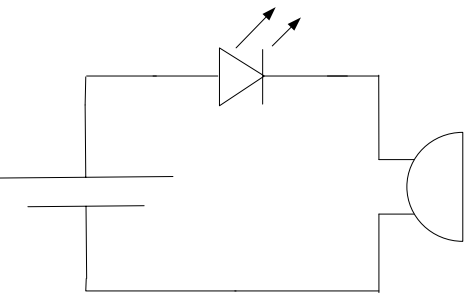
	Parallel connection: YES	Series Connection: NO
Two LEDs	<p>NOTE: LED's must be same color, or combination of yellow & red; green will not work with either yellow or red.</p> 	
LED & Buzzer		

Motor circuits

A motor requires an AA battery – if you use a coin battery to run a motor, it will go dead very quickly.

Adding switches

Each circuit should have its own switch. A simple switch cannot be shared between two separate circuits, each with its own battery.

Lesson 11: Gearing up for the Auto Show

Overview

Students continue to work on their improved cars, write Instruction Manuals, and prepare for presenting their work in the next lesson.

Materials

- ✦ Partially completed improved cars from Lesson 10
- ✦ Materials for adding lights and horns: AA batteries, LEDs, buzzers, coin batteries, paper fasteners, paper clips, aluminum foil, galvanized wire, rubber bands, cardstock, cardboard, scissors, tape, foam
- ✦ Craft materials: Ribbon, pom-poms, paper streamers, yarn, felt, pipe cleaners, beads, buttons, etc. (as available) for decorating vehicles
- ✦ Re-closable 2-gallon storage bags to hold work-in-progress.

Procedure

1. Continuing work on improved cars: Students complete making their cars, test them, troubleshoot, and redesign as necessary.

Science Notebook

- ✓ Write and draw what you made.
- ✓ List the problems that came up, and what you did to troubleshoot each one.
- ✓ What did you learn from doing this project?

2. Instructions for using your car: Someone might not know what they would have to do to activate the lights, horn or motor.. Ask each student to attach a short instruction guide, such as “Press here to operate horn,” which will tell the user what to do.

Outcomes

- ✦ An Instruction Manual is needed for telling a user how to operate your product. .

Lesson 12: The Auto Show

Overview

Students design ways of presenting their cars to an audience.

Materials

- ✦ Cars completed in Lesson 11

Procedure

1. Completing cars: Students complete their cars and prepare them for presentations.
2. Presenting EnerJeeps: This is the culminating lesson, where students will present their final products to an audience. The Auto Show could take one or more of several forms:
 - ✦ **Formal presentation**: each student shows his or her car to an audience and explains what he or she did to make it.
 - ✦ **Museum**: Students create a display on tables, where visitors can view the cars and try them out for themselves
 - ✦ **Invention Convention**: Like a Science Fair, visitors come to view the cars, test them out and talk with the students who made them.

The completed Instruction Manual and Troubleshooting Guide should be included in each presentation.

The Digital Multimeter (DMM): A Guide for Teachers

1. What is a Digital Multimeter?

A meter is a device that measures electrical quantities. Your electric bill is based on the amount of electrical energy you used, which the electric company measures with a kilowatt-hour meter. When you are making and testing small circuits, the most important quantities are **voltage**, **current** and **continuity**. A **digital multimeter** (DMM) is a convenient handheld device that can measure any of these – therefore the prefix “multi” – and provide the results on a digital display. With a little practice, you can use it to check a battery, test a switch, discover why a red LED will turn a green one off when both are connected in parallel, learn about how a motor works, and much, much more. In the next few pages, we’ll show you how to set up a DMM, use to make some basic measurements, and then suggest some experiments you can do to learn a lot more about circuits.

2. Setting up a DMM

When the meter is not in use, it should be turned off. The switch has a little triangle on it, which should be pointing to the top center position marked “OFF,” as shown in the diagram below. In addition to the meter itself, there are only two other components that come in the box, and that you need to start making measurements: a red and a black **probe**. For nearly all measurements, these plug into the two **jacks** (receptacles) on the bottom right. The shrouded ends with the right-angle connectors are the ends that go into the jacks. Plug the black probe into the jack labeled “COM” (for “Common”) and the red probe into the jack labeled “V Ω mA”. See diagram below.

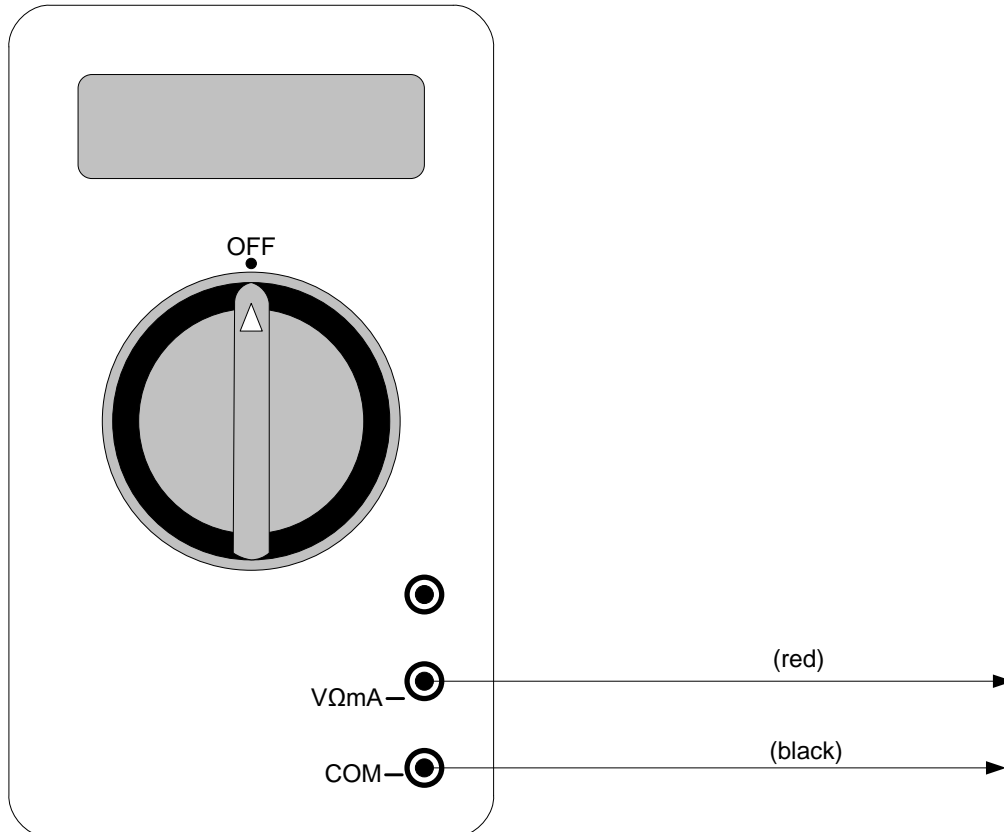

3. Using the Multimeter as a voltmeter: Testing a battery

Now you are ready to make your first measurement. Let's begin by checking a coin battery. a battery is a source of **direct current** (DC), which means that the direction of the current does not vary. A wall socket is a source of alternating current, which does vary in direction.

SAFETY NOTE: DO NOT ATTACH ANYTHING TO A WALL SOCKET, IN THIS UNIT.

The meter has a switch that allows you to select both a **function** – what quantity you are measuring – and a **range** – the maximum measurement you can make. Turn the switch to put the meter ON in the “20” range within the DV Voltage function. The maximum measurement will then be 20 Volts DC. The diagram shows how. The Voltage ranges are indicated by “V” and the DC ranges use the icon --- . Then attach the red probe to the (+) side of the battery and the black probe to the (—) side of the same battery.

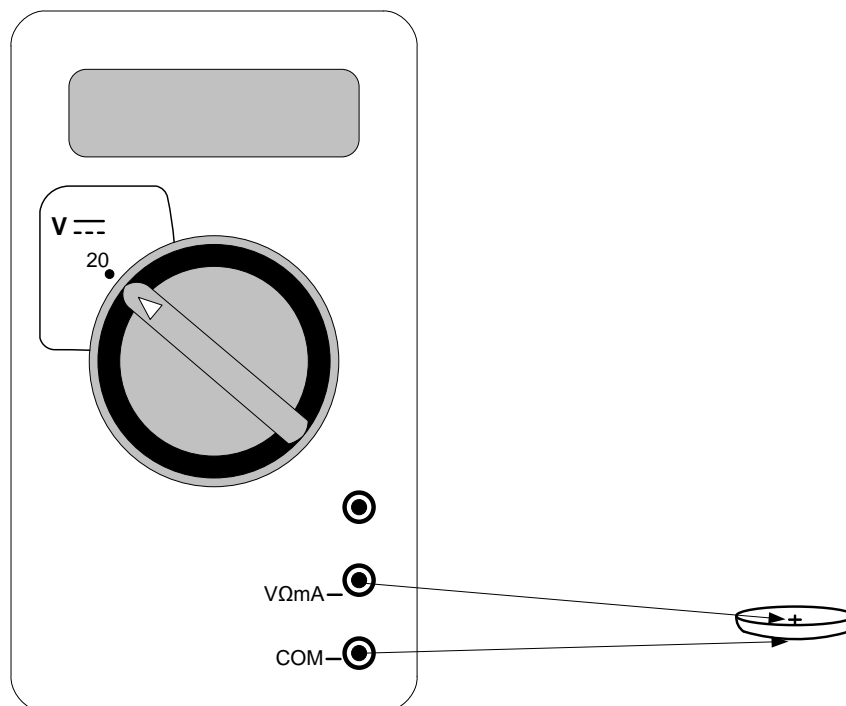

The meter should read around 3.0, which is the rated voltage of the battery. If the reading is zero, make sure the red and black connectors are pushed all the way down into the jacks, and that the probe ends are pressed hard against the battery terminals. If the reading is still zero, the battery may be dead. If there is a (—) sign in front of the reading, just reverse the two probes. Then use the same technique to measure the voltage of an AA battery, which is rated at 1.5 Volts.

A multimeter used to measure voltage is called a **voltmeter**. The circuit diagram symbol for a voltmeter is a circle with a “V” in it. Here is a diagram that shows the circuit pictured above:

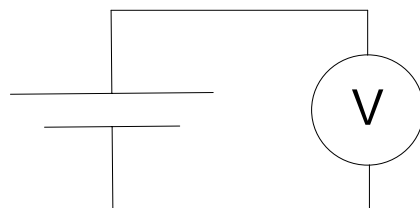

4. Testing for a bad connection to a battery

Often, a battery is good, but the wires to it are not making good contact. Using the same method as for testing a battery, you can find out if the connections are good, and even which one is bad. The drawing below shows the meter testing the connections to an AA battery:

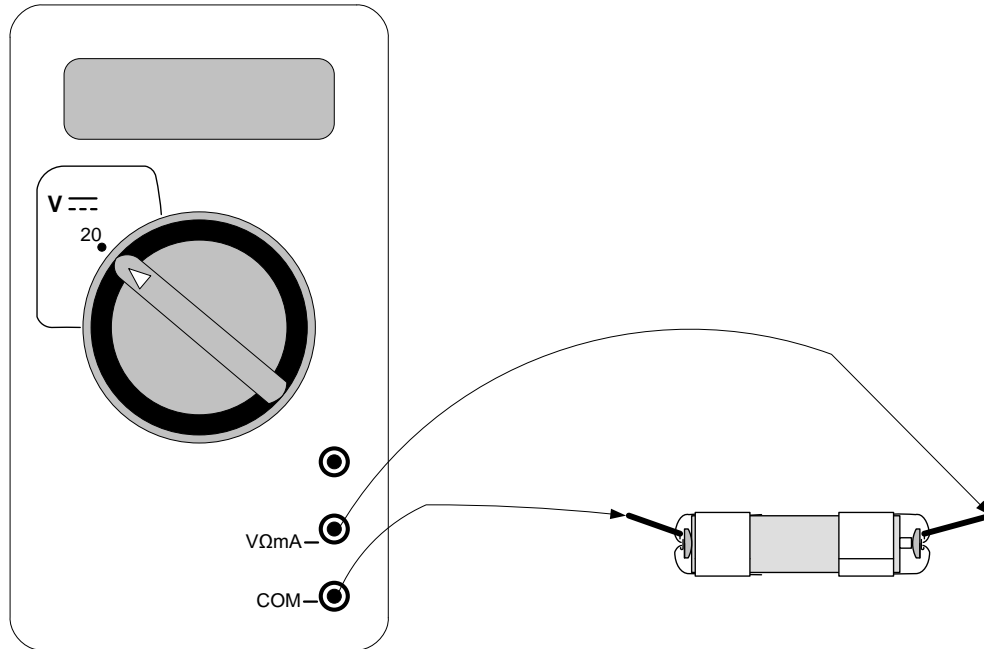

The reading on the meter should be close to 1.5 Volts. If not, touch the battery terminals directly, to see if the battery is good. If it is, but the voltage does not appear along the wires, then one or both of the connections are bad. Find out which one by moving one of the probes at a time. When the reading disappears, you have found the bad connection. The table below shows how:

Probe locations	Is there a voltage reading?	
	YES	NO
	All connections are good	Test each connection
	Left connection is probably bad	Test right connection and battery
	Right connection is probably bad	Test left connection and battery
	Battery is good	Battery is bad, or probe is not making contact

5. Learning more about batteries

Here are some experiments to try with a coin battery:

- ✦ **Turn the battery around**, as shown below. Predict the result of reading the voltage, and then check to see if you were right.

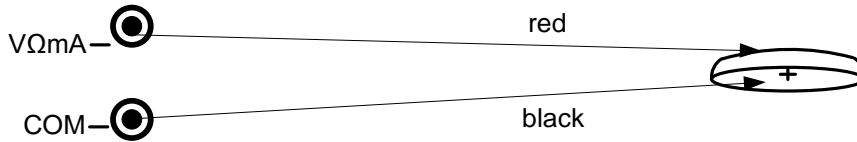

- ✦ **Test two batteries in series**. There are four ways to arrange these, as shown in the table below, which also includes circuit diagrams. Predict and record each result. Approximate expected values are given below the table.

	Drawing	Diagram	Voltage Reading	
			Predicted	Actual
A				
B				
C				
D				

Expected results: A) + 6 Volts; B) 0 Volts; C) 0 Volts; D) – 6 Volts

6. Using a Voltmeter to learn more about LEDs

Students may have noticed that if you connect a red or yellow LED in parallel with a blue or green LED, only the red or yellow one will stay on. Why does this happen? Using a multimeter, it is easy to find out.

Use the same arrangement as you did to test a battery (see previous page), but this time also press the wires from a red LED against the battery so the LED comes on. Recall that the long wire has to be touching the (+) side of the battery. See the picture below:

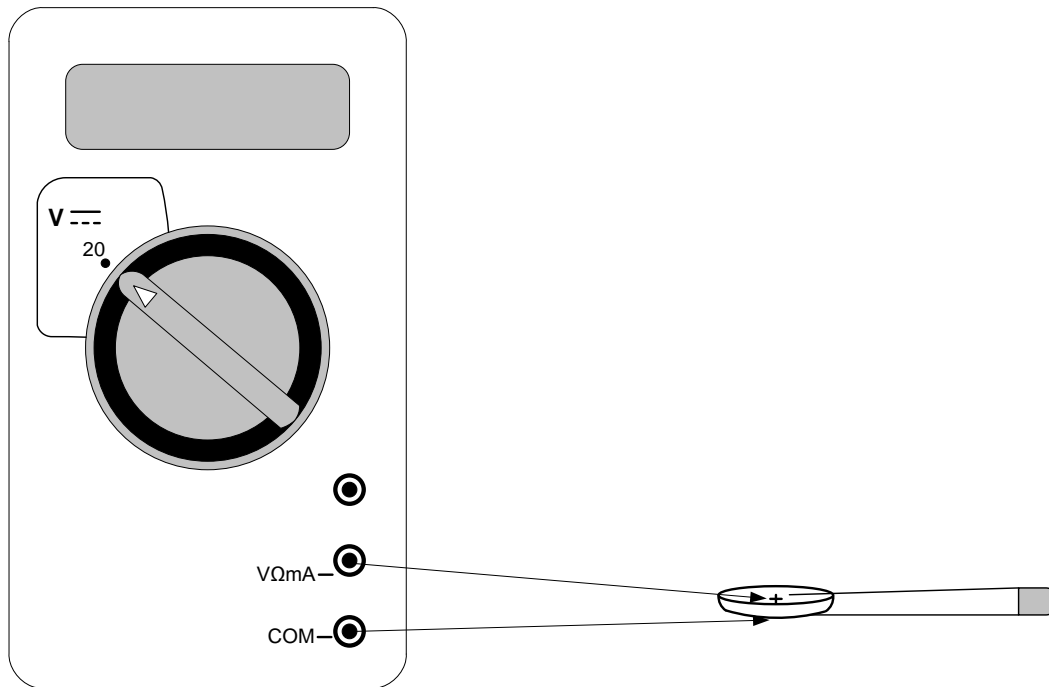

The reading on the meter will tell you how much voltage the LED uses to turn on. Record this number. Now repeat the experiment with each of the other colors: yellow, green and blue. Record the voltage of each one. What do you notice?

Typically, a red or yellow LEDs will take only about 2.2 or 2.3 Volts – less than the full voltage of a coin battery, while the blue and green LED need about 2.9 Volts, which is nearly the full battery voltage. This helps to explain why a red or yellow LED will turn off a blue or green one when two are in parallel. The red or yellow LED will not allow the blue or green one to get to the greater voltage it needs to turn on. Also, an AA battery won't light any of the LEDs, because it only supplies 1.5 Volts, while the LEDs all need more than 2 Volts.

Something else to notice from this experiment is how a voltmeter needs to be connected. Here is a diagram of the circuit shown above:

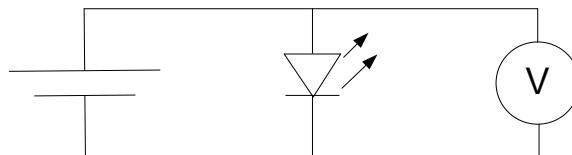

From this diagram, look at how the voltmeter is connected across the LED. A voltmeter has to be connected **in parallel** with the component whose voltage is being measured.

It may seem confusing that the components are shown in a different order in the diagram, compared with the picture. The convention in a diagram is to show the battery at the left, because it is the source or input, and the voltmeter at the right, because it is not an essential part of the circuit. The circuit works exactly the same way, regardless of which component is on the left or right, as long as they remain in parallel.

7. Looking for continuity: Testing a switch and finding out if a material is a conductor

You can also use a multimeter as a **continuity tester** – a device for checking whether or not parts of a circuit are actually connected electrically. To test for continuity, you use one of the ranges within the function group marked by a “Ω,” which is the Greek letter Omega. (Electrical resistance is measured in Ohms, Ω for short – but we need not worry about these details, because we will be using an Ω range only to find out if there is a connection or not.)

To test for continuity, keep the probes in the same place they were in for measuring voltage (see previous two pages) and turn the switch on the meter to the “200K” range within the Ω function. The picture shows how to set this up:

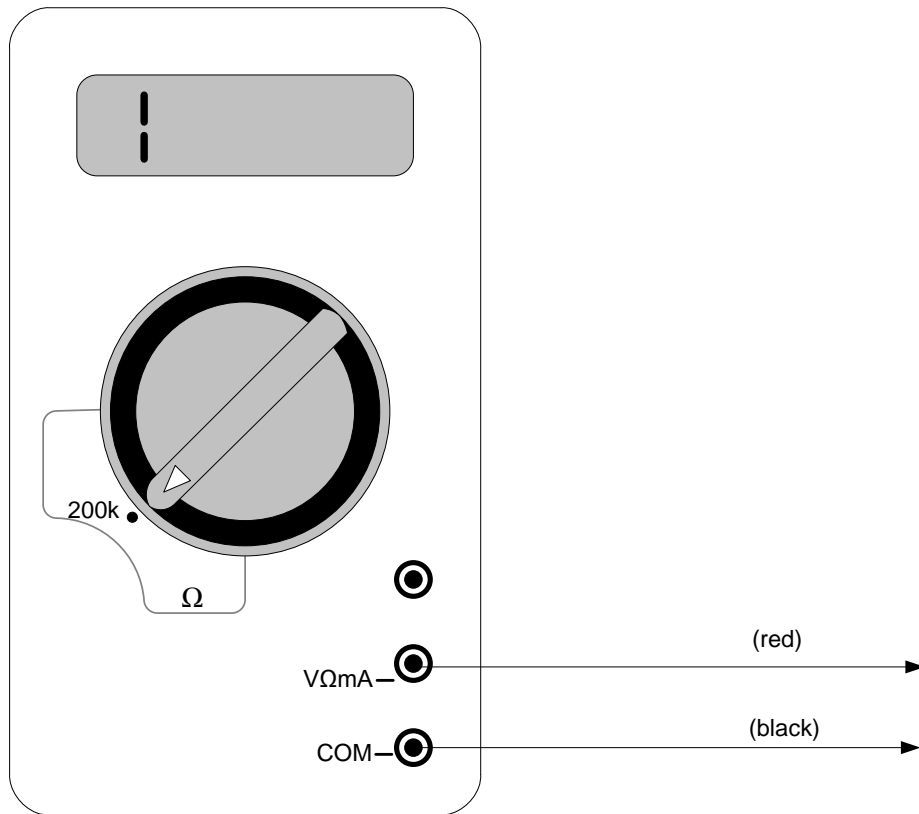

If you have done this correctly, the number “1” should appear in the display. Next touch the two metal probe ends together, and the display should change to “0.00”. The table below shows what what the numbers mean:

Display	Is there an electrical connection (continuity) between the two probes?
1	NO
0.00	YES

When a multimeter tests for continuity, it uses a battery, which is inside. To protect the battery, please observe these two rules:

- ✦ **Test individual components only.** Do not test for continuity in a circuit that has a battery connected. Doing so can harm the battery inside the Multimeter.
- ✦ **Do not leave the meter on for very long in one of the Ω ranges.** Doing so can drain the battery inside the Multimeter.

Now you can use the continuity tester to find out whether there is a connection between circuit elements. Let's begin by testing a homemade switch. The drawing below shows an example of a meter being used to test rotary switch made from two paper fasteners and a paper clip:

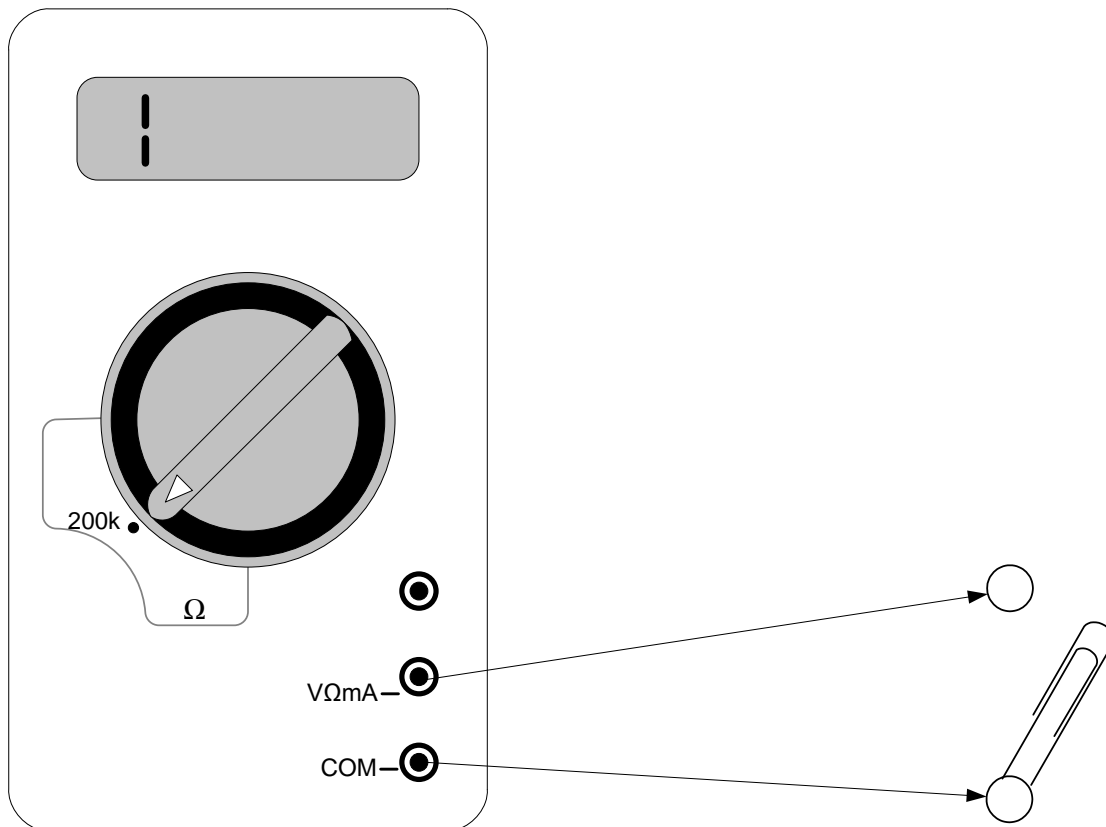

When the switch is open, as shown above, there should be no connection between the two paper fasteners, and the meter should read “1”.

Now close the switch by touching the paper clip to both paper fasteners. The paper clip should make an electrical connection between them, so the meter should now read “0.00”. The meter provides an easy way to test a switch without using your own battery, LED or motor.

You can use the same method to test whether a material is a conductor or an insulator. Just touch one probe on each end. If it is a conductor, there will be electrical contact and the meter will read “0.00”; if it is an insulator, there will be no contact and it will read “1”.

8. Using a Multimeter to measure current: Comparing batteries and exploring motors

A multimeter can also serve to measure **current**, which is the rate of flow of electrical charges past a point. Since current is measured in **Amps**, which is short for “Amperes”, and is abbreviated A. Any device that measures current is called an **Ammeter**. When you use the multimeter as an Ammeter, there are a few precautions you need to take, not only to get an accurate reading, but also to protect the meter from damage. Here are the rules for measuring current:

- ✦ Once again, **DO NOT ATTACH ANYTHING IN THIS UNIT TO A WALL OUTLET.**
- ✦ **The Ammeter must be in series with the other circuit elements.** This is different from the voltmeter, which must be in parallel.
- ✦ **Use the highest current range, which is 10 Amps.** Set the meter switch on 10A as shown in the drawing below.
- ✦ **DO NOT USE THE MIDDLE JACK MARKED “VΩmA”.** The 10 Amp current range has a special jack labeled “10 A.” be. Move the red probe to the top jack, which is also shown in the drawing.

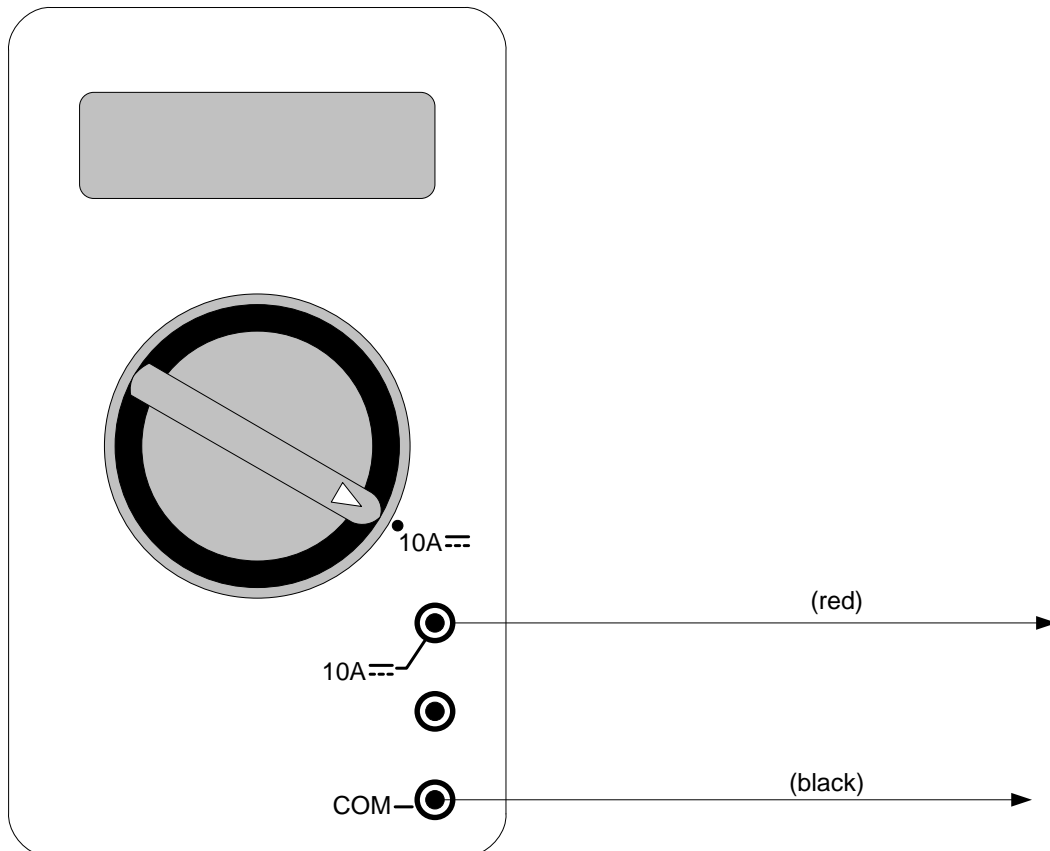

Now you are ready to make current measurements. These readings can help to answer the following questions, which may have come up while working with motors and LEDs:

- ✦ **What's the difference between a little battery and a big one?** Some batteries are bigger than others, but the size doesn't usually seem related to voltage. For example, a D cell is bigger than an AA, but both supply 1.5 Volts, and a coin battery is even smaller, but provides 3 Volts.
- ✦ **Why won't a coin battery run a motor?** As we will see, this question is closely related to the previous one.
- ✦ **What changes electrically when a motor is turning something?** Using two AA batteries you can operate both an LED and a motor in parallel, as shown in the diagram below:

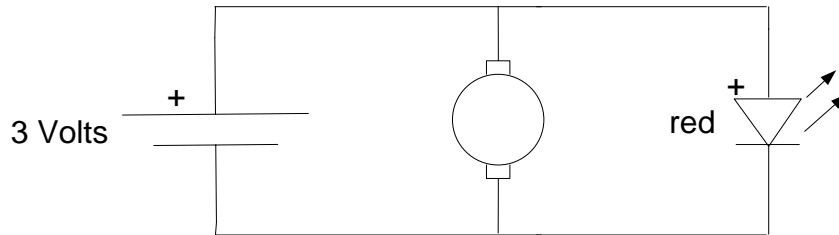

Both the motor and LED should work fine, as long as the motor isn't turning a wheel or pulley. However, as soon as there is some weight on the motor shaft, the LED will begin to get dim. The weight could come from adding a wheel; or worse, driving a car or adding weight to the wheel; or worse yet, preventing the wheel from turning at all. If there is enough weight, the motor will continue trying to turn, but the LED will go out.

9. Comparing batteries

Attach the meter directly to a coin battery as shown below. Record the current reading.

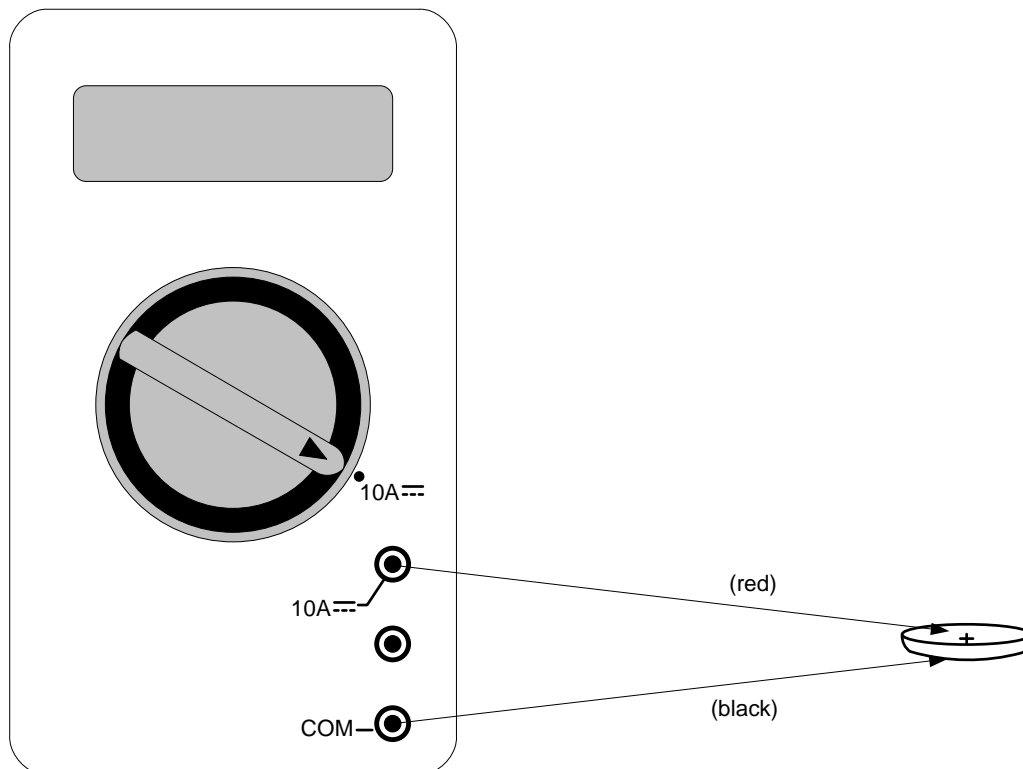

Next, use the same method to test any other battery you have available. For example you could measure the current supplied by a AAA, AA, C, D, 6-Volt square lantern battery or rectangular 9-Volt battery. Record the result of each measurement. What you obtain in each case is the maximum current the battery can provide. Typical results are that a coin battery can provide only about 0.1 A.; an AA supplies over 1 A., a D cell's maximum current is close to 2 A., and a 6-Volt lantern battery provides more than 5 A. How do these results shed light on why batteries come in different sizes?

If there is any **load** attached to the battery, such as a motor, LED or buzzer, the battery will provide less than the maximum current. The next set of experiments looks at the amount of current drawn by each type of load.

10. How much current do LEDs, buzzers and motors require?

The next step is to attach various loads to a battery, to see how much current each one is looking for. Let's begin with a motor. We already know that it won't work from a coin battery, so use an AA. Recall from before that an Ammeter has to be **in series** with a load – not in parallel, as with a voltmeter. The drawing and diagram below show how to attach the motor **in series** with the meter. The circuit diagram inside the box represents the same circuit. Notice the symbol for an Ammeter, which is a circle with an "A" inside.

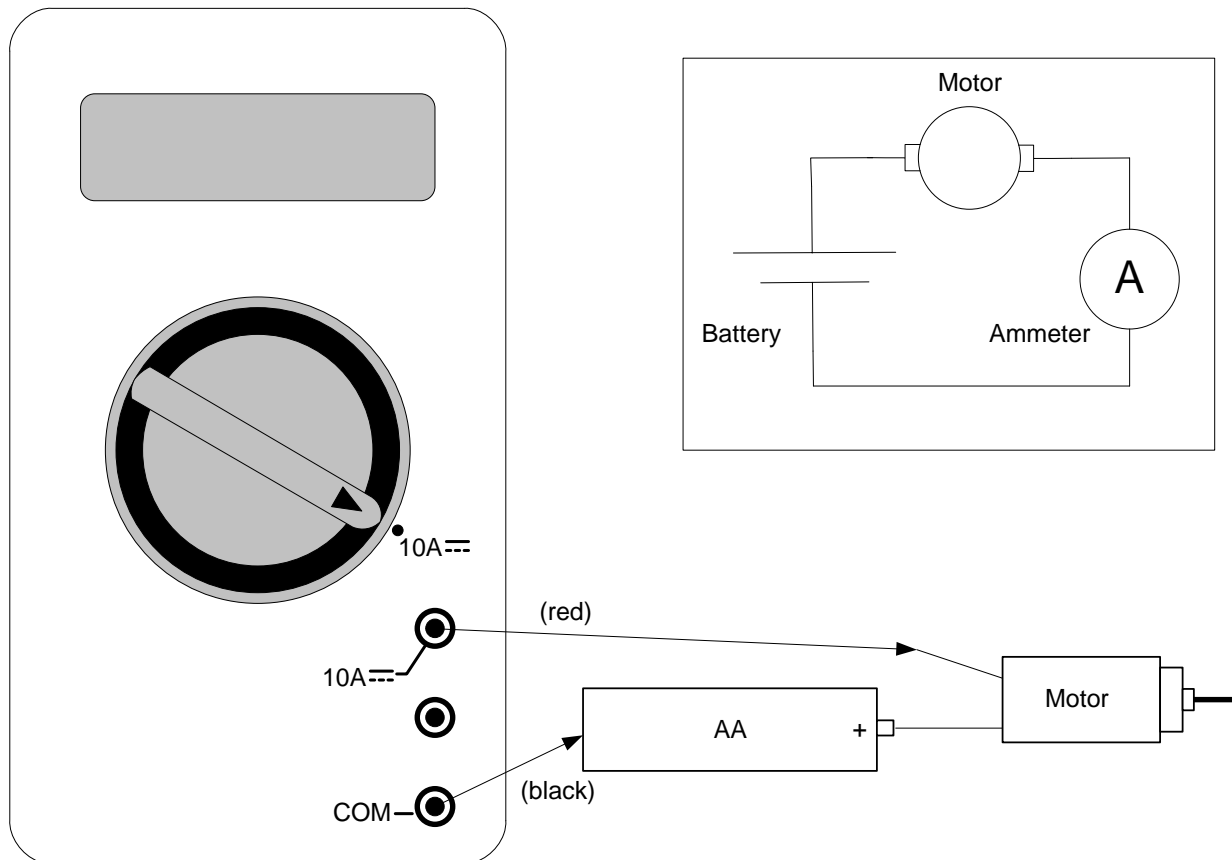

The motor is likely to draw between 0.1 and 0.2 Amps – much less than the maximum current a AA battery can supply.

Next, test a red LED. It won't run off of a AA battery, so this time use a coin battery. The circuit is shown in the drawing and diagram below.

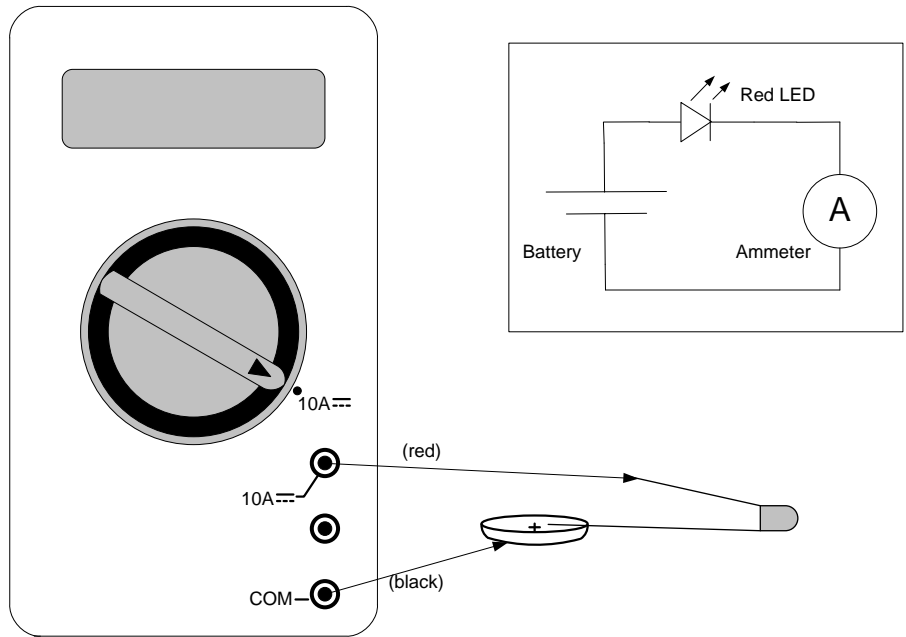

This time, the current will be much less – perhaps about 0.04 Amps. To get a more accurate reading, use the next lowest range of the meter, which is 200 mA, marked “200 m” on the switch. “m” stands for “milli,” which stands for “one thousandth” just as in millimeter or milligram. 200 mA. is the same as 0.2 A., which is considerably more than you are measuring, so it is safe to use the meter on that scale. **You will also need to move the red probe back to the “VΩmA” jack.** See diagram below:

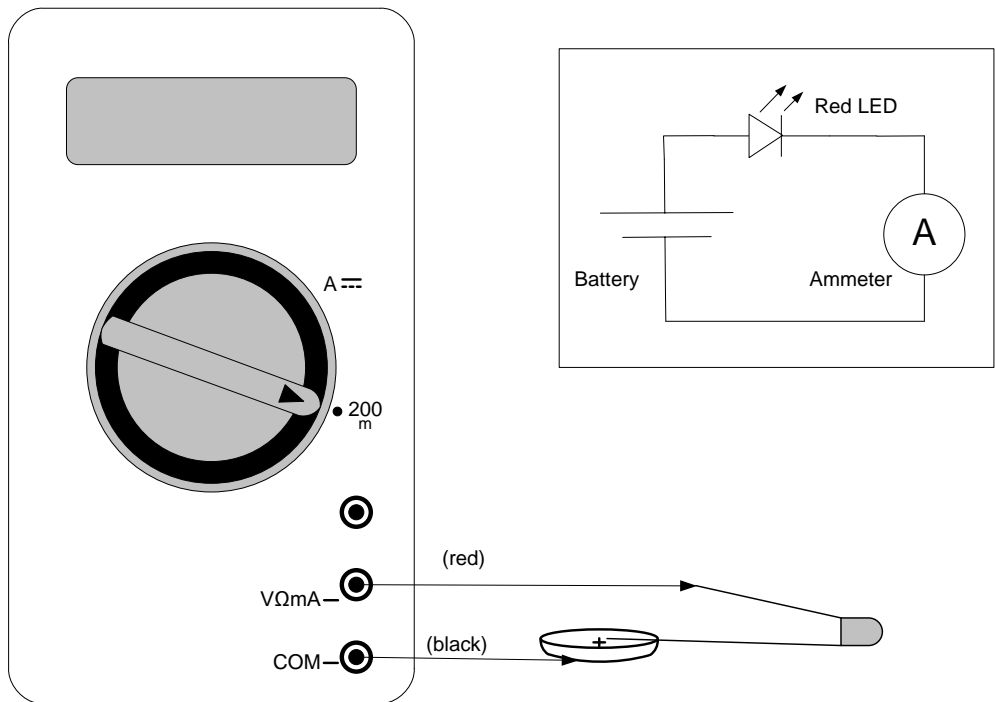

You should get a reading, around 40 mA, which is the same as 0.04 A. Use the same method to test the yellow, green and blue LEDs, as well as the buzzer. The yellow LED should require roughly the same current as the red LED. The buzzer, blue and green LEDs use much less current, less than 10 mA. each. What do these results tell us about why LEDs and buzzers can run on coin batteries, but not motors?

11. What happens to a motor when it is working harder?

The last experiment explores the effect of adding weight to a motor. Restore the meter to the 10 A. range. **Be certain to move the red probe back to the 10A jack.** Then attach a wheel to the motor, using a bushing to get a tight fit. See the drawing below.

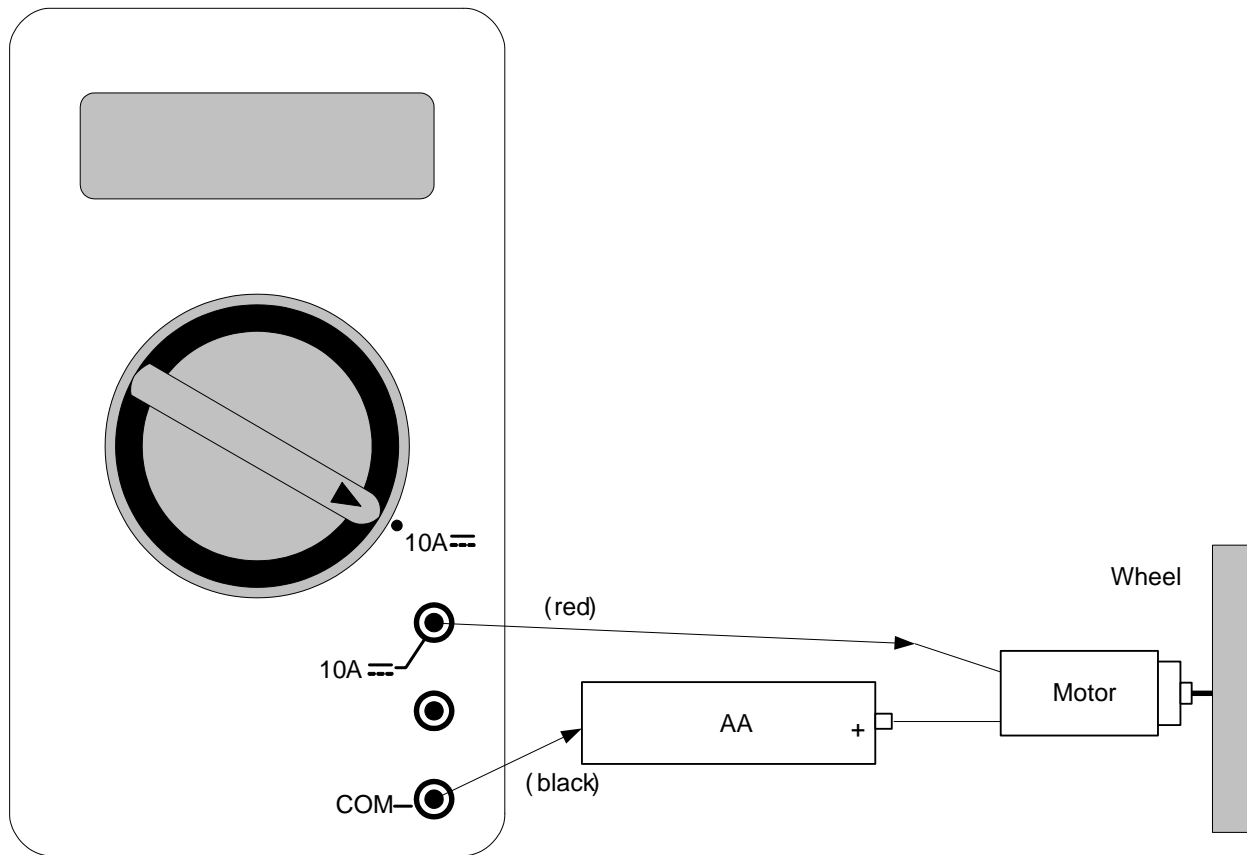

Now measure the current that motor uses. It will be much larger than the 0.1 – 0.2 Amps that measured before without the wheel – perhaps about 0.4 Amps or so. To see the current change even more, here are some things you can try:

- ✦ Add weight to the wheel, by taping a penny or other weight towards the edge.
- ✦ Slow the wheel and motor down, by forcing it to turn against something hard, such as a desk or table.
- ✦ Stop it completely, by holding it while it is still trying to turn.

Each of these actions should increase the current even more – possibly to 1 Amp or more, which is close to the maximum an AA battery can supply. What does this experiment reveal about how